

TEST REPORT

Product Name : Pocket WiFi+LAN

Model Number : Pocket WiFi+LAN

Prepared for : SOLAX POWER NETWORK TECHNOLOGY (ZHEJIANG)
CO., LTD.

Address : No.288, Shizhu Road, Tonglu Economic Development
Zone, Tonglu City, Zhejiang Province 310000, P. R. China

Prepared by : EMTEK (NINGBO) CO., LTD.
Address : No. 8, Building 8, Lane 216, Qingyi Road, Ningbo Hi-Tech
Zone, Ningbo, Zhejiang, China

Tel: +86-574-27907998

Fax: +86-574-27721538

Report Number : ENB2301300046E00201R

Date(s) of Tests : January 30, 2023 to February 17, 2023

Date of issue : March 08, 2023



TABLE OF CONTENT

Test Report Description	Page
1. DESCRIPTION OF STANDARDS AND RESULTS (EUT)	6
2. GENERAL INFORMATION	7
2.1. Description of Device (EUT)	7
2.2. Input / Output Ports.....	7
2.3. Independent Operation Modes	7
2.4. Test Manner	8
2.5. Description of Support Device	8
2.6. Description of Test Facility	9
2.7. Test Software	9
2.8. Measurement Uncertainty.....	10
3. MEASURING DEVICE AND TEST EQUIPMENT	11
3.1. For Power Line Conducted Emission Measurement	11
3.2. For Conducted Emissions at Telecommunications/network port Measurement.....	11
3.3. For Radiated Emission Measurement (Up to 1 GHz).....	12
3.4. For Radiated Emission Measurement (Above 1 GHz)	12
3.5. For Harmonic Current/Flicker Measurement	13
3.6. For Electrostatic Discharge Immunity Test	13
3.7. For RF Strength Susceptibility Test	13
3.8. For Electrical Fast Transient /Burst Immunity Test	14
3.9. For Surge Immunity Test.....	14
3.10. For Injected Current Susceptibility Test	15
3.11. For Voltage Dips and Interruptions Test.....	15
4. CONDUCTED EMISSIONS FROM THE AC MAINS POWER PORTS	16
4.1. Block Diagram of Test Setup	16
4.2. Limits.....	16
4.3. Test Procedure.....	16
4.4. Measuring Results	17
5. ASYMMETRIC MODE CONDUCTED EMISSIONS AT WIRED NETWORK PORTS	22
5.1. Block Diagram of Test Setup	22
5.2. Limits.....	22
5.3. Test Procedure.....	22
5.4. Measuring Results	23
6. RADIATED EMISSION MEASUREMENT (UP TO 1GHZ)	25
6.1. Block Diagram of Test Setup	25
6.2. Radiated Limit.....	25
6.3. Test Procedure.....	25
6.4. Measuring Results	26
7. RADIATED EMISSION MEASUREMENT (ABOVE 1GHZ)	31
7.1. Block Diagram of Test Setup	31
7.2. Radiated Limit.....	31
7.3. Test Procedure.....	32
7.4. Measuring Results	32
8. HARMONIC CURRENT EMISSION MEASUREMENT	37
8.1. Block Diagram of Test Setup	37
8.2. Standard Limits	37
8.3. Test Procedure.....	38
8.4. Test Results	38
9. VOLTAGE FLUCTUATION AND FLICKER MEASUREMENT	45
9.1. Block Diagram of Test Setup	45

9.2. Standard Limits	45
9.3. Test Procedure	45
9.4. Test Results	45
10. IMMUNITY GENERAL PERFORMANCE CRITERIA DESCRIPTION	48
11. ELECTROSTATIC DISCHARGE	49
11.1. Test Specification	49
11.2. Block Diagram of Test Setup	49
11.3. Test Procedure	49
11.4. Test Results	50
12. CONTINUOUS RF ELECTROMAGNETIC FIELD DISTURBANCES	51
12.1. Test Specification	51
12.2. Block Diagram of Test Setup	51
12.3. Test procedure	51
12.4. Test results	52
13. ELECTRICAL FAST TRANSIENTS/BURST	53
13.1. Test Specification	53
13.2. Block Diagram of Test Setup	53
13.3. Test Procedure	54
13.4. Test Results	54
14. SURGES	55
14.1. Test Specification	55
14.2. Block Diagram of Test Setup	55
14.3. Test Procedure	55
14.4. Test results	56
15. CONTINUOUS INDUCED RF DISTURBANCES	57
15.1. Test Specification	57
15.2. Block Diagram of Test Setup	57
15.3. Test Procedure	57
15.4. Test results	58
16. VOLTAGE DIPS AND INTERRUPTIONS	59
16.1. Test Specification	59
16.2. Block Diagram of Test Setup	59
16.3. Test Procedure	59
16.4. Test results	60
17. PHOTOGRAPHS	61
17.1. Photo of Conducted Emission Measurement	61
17.2. Photo of Conducted Emissions at Telecommunications/network port Measurement	62
17.3. Photo of Radiation Emission Measurement (Up to 1GHz)	63
17.4. Photo of Radiation Emission Measurement (Above 1GHz)	64
17.5. Photo of Harmonic and Flicker Measurement	65
17.6. Photo of Electrostatic Discharge Test	65
17.7. Photo of RF Field Strength Susceptibility Test	66
17.8. Photo of Electrical Fast Transient /Burst Test	66
17.9. Photo of Surge Test	67
17.10. Photo of Injected Currents Susceptibility Test	67
17.11. Photo of Voltage Dips and Interruption Immunity Test	68

APPENDIX (Photos of the EUT) (3 Pages)

TEST REPORT DESCRIPTION

Applicant : SOLAX POWER NETWORK TECHNOLOGY (ZHEJIANG) CO., LTD.
Manufacturer : SOLAX POWER NETWORK TECHNOLOGY (ZHEJIANG) CO., LTD.
Trade Mark : SolaX Power
EUT : Pocket WiFi+LAN
Model Number : Pocket WiFi+LAN
Input Voltage : DC 5V (For USB)

Measurement Procedure Used:

EN 55032:2015+A1:2020

EN IEC 61000-3-2:2019+A1:2021

EN 61000-3-3:2013/A2:2021

EN 55035:2017+A11:2020

(IEC 61000-4-2:2008, IEC 61000-4-3:2006+A1:2007+A2:2010, IEC 61000-4-4:2012,
IEC 61000-4-5:2005, IEC 61000-4-6:2008, IEC 61000-4-8:2009, IEC 61000-4-11:2004)

The device described above is tested by EMTEK (NINGBO) CO., LTD. to determine the maximum emission levels emanating from the device and the severe levels of the device can endure and its performance criterion. The measurement results are contained in this test report and EMTEK (NINGBO) CO., LTD. is assumed full of responsibility for the accuracy and completeness of these measurements. Also, this report shows that the EUT (Equipment Under Test) is technically compliant with the EN 55032, EN IEC 61000-3-2, EN 61000-3-3, EN 55035 requirements.

This report applies to above tested sample only and shall not be reproduced in part without written approval of EMTEK (NINGBO) CO., LTD.

Date of Test : January 30, 2023 to February 17, 2023

Prepared by : 
June Gao/Engineer

Reviewer : 
Ade Wang/Supervisor

Approved & Authorized Signer : 
Tony Wei/Manager



Modified Information

Version	Report No.	Revision Date	Summary
	ENB2301300046E00201R	/	Original Report



1. DESCRIPTION OF STANDARDS AND RESULTS (EUT)

EMISSION				
Description of Test Item		Standard	Limits	Results
Conducted Emissions From the AC Mains Power Ports		EN 55032:2015+A1:2020	Class B	Pass
Asymmetric mode conducted emissions	Wired network ports	EN 55032:2015+A1:2020	Class B	Pass
	Optical fibre ports	EN 55032:2015+A1:2020	Class B	N/A
	Broadcast receiver tuner ports	EN 55032:2015+A1:2020	Class B	N/A
	Antenna ports	EN 55032:2015+A1:2020	Class B	N/A
Conducted differential voltage emissions	TV broadcast receiver tuner ports	EN 55032:2015+A1:2020	Class B	N/A
	RF modulator output ports	EN 55032:2015+A1:2020	Class B	N/A
	FM broadcast receiver tuner ports	EN 55032:2015+A1:2020	Class B	N/A
Radiated emissions at frequencies up to 1 GHz		EN 55032:2015+A1:2020	Class B	Pass
Radiated emissions at frequencies above 1 GHz		EN 55032:2015+A1:2020	Class B	Pass
Radiated emissions from FM receivers		EN 55032:2015+A1:2020	Table A.6	N/A
Outdoor units of home satellite receiving systems		EN 55032:2015+A1:2020	Table A.7	N/A
Harmonic Current Emissions		EN IEC 61000-3-2:2019+A1:2021	Class A	Pass
Voltage Fluctuation and Flicker		EN 61000-3-3:2013/A2:2021	Section 5	Pass
IMMUNITY(EN 55035:2017+A11:2020)				
Description of Test Item		Basic Standard	Performance Criteria	Results
Electrostatic Discharge	Enclosure ports	IEC 61000-4-2:2008	B	Pass
Continuous RF electromagnetic field disturbances	Enclosure ports	IEC 61000-4-3:2006+A1:2007+A2:2010	A	Pass
Electrical fast transients/burst	AC mains power ports	IEC61000-4-4:2012	B	Pass
	Analogue/digital data ports		B	Pass
	DC network power ports		B	N/A
Surges	AC mains power ports	IEC 61000-4-5:2005	B	Pass
	Analogue/digital data ports for unshielded symmetrical		C	Pass
	Analogue/digital data ports for coaxial or shielded		B	N/A
	DC network power ports		B	N/A
Continuous induced RF disturbances	AC mains power ports	IEC 61000-4-6:2008	A	Pass
	Analogue/digital data ports		A	Pass
	DC network power ports		A	N/A
Power frequency magnetic field	Enclosure ports	IEC 61000-4-8:2009	A	N/A
Voltage dips and interruptions	AC mains power ports	IEC 61000-4-11:2004	B,C	Pass
Broadband impulsive conducted disturbances	Analogue/digital data ports	\	N/A	N/A
Note: N/A is an abbreviation for Not Applicable.				

2. GENERAL INFORMATION

2.1. Description of Device (EUT)

EUT	:	Pocket WiFi+LAN
Model Number	:	Pocket WiFi+LAN
Test Voltage	:	AC 230V/50Hz (For Support Device), DC 5V
Highest Frequency	:	2400 MHz
Sample Number	:	ENB2301300046E002-1-1
Applicant	:	SOLAX POWER NETWORK TECHNOLOGY (ZHEJIANG) CO., LTD.
Address	:	No.288, Shizhu Road, Tonglu Economic Development Zone, Tonglu City, Zhejiang Province 310000, P. R. China
Manufacturer	:	SOLAX POWER NETWORK TECHNOLOGY (ZHEJIANG) CO., LTD.
Address	:	No.288, Shizhu Road, Tonglu Economic Development Zone, Tonglu City, Zhejiang Province 310000, P. R. China
Date of Received	:	January 30, 2023
Date of Test	:	January 30, 2023 to February 17, 2023

2.2. Input / Output Ports

Port #	Name	Type*	Cable Max. >3m	Cable Shielded	Comments
1	Enclosure	N/E	--	--	None
2	USB Port	DC	--	--	None

*Note: Use abbreviations:

AC= AC Power port

DC= DC Power port

N/E= Non-Electrical

A/D=Analogue/digital data port (signal/control port, antenna port, wired network port, broadcast receiver tuner port, optical fibre port)

2.3. Independent Operation Modes

- A. WIFI
- B. WIRED

2.4. Test Manner

Test Items	Test Voltage	Operation Modes	Worst case
Conducted disturbance at mains Terminals	AC 230V/50Hz	Mode A Mode B	Mode A Mode B
Asymmetric mode conducted emissions	AC 230V/50Hz	Mode B	Mode B
Radiated emissions at frequencies up to 1 GHz	DC 5V	Mode A Mode B	Mode A Mode B
Radiated emissions at frequencies above 1 GHz	DC 5V	Mode A Mode B	Mode A Mode B
Harmonic Current Emissions	AC 230V/50Hz	Mode A Mode B	Mode A Mode B
Voltage Fluctuation and Flicker	AC 230V/50Hz	Mode A Mode B	Mode A Mode B
Electrostatic Discharge	DC 5V	Mode A Mode B	Mode A Mode B
Continuous RF Electromagnetic Field Disturbances	DC 5V	Mode A Mode B	Mode A Mode B
Electrical Fast Transient / Burst	AC 230V/50Hz	Mode A Mode B	Mode A Mode B
Surges	AC 230V/50Hz	Mode A Mode B	Mode A Mode B
Continuous induced RF disturbances	AC 230V/50Hz	Mode A Mode B	Mode A Mode B
Voltage dips and interruptions	AC 230V/50Hz	Mode A Mode B	Mode A Mode B

2.5. Description of Support Device

Notebook : Manufacturer: LENOVO
M/N: T430s
S/N: R9RK4YK

2.6. Description of Test Facility

Site Description
EMC Lab. A

: **Accredited by CNAS**

The Certificate Registration Number is L6666.

The Laboratory has been assessed and proved to be in compliance with CNAS-CL01:2018 (identical to ISO/IEC 17025:2017)

Accredited by FCC

Designation Number: CN1302

Test Firm Registration Number: 436491

Accredited by A2LA

The certificate is valid until May 31, 2023

Accredited by Industry Canada

The Conformity Assessment Body Identifier is CN0114

Name of Firm

: EMTEK (NINGBO) CO., LTD.

Site Location

: No. 8, Building 8, Lane 216, Qingyi Road, Ningbo Hi-Tech Zone, Ningbo, Zhejiang, China

2.7. Test Software

Item

Software

Conducted Emission

: TS+ (Ver.4.0.0.0)

Radiated Emission

: TS+ (Ver.4.0.0.0)

2.8. Measurement Uncertainty

Test Item	Uncertainty
Conducted Emission Uncertainty	: 2.08dB (9 k-150 kHz) 2.40dB (150 k-30 MHz)
Radiated Emission Uncertainty (3m Chamber)	: 4.06dB (Polarize: H) (30MHz-1000MHz) 4.04dB (Polarize: V) (30MHz-1000MHz) 4.82dB (Polarize: H) (1~18GHz) 4.80dB (Polarize: V) (1~18GHz)
Uncertainty for Harmonic test	: 4.16% mA
Uncertainty for Flicker test	: 0.43% V
Uncertainty for ESD Test	: 6.00% kV
Uncertainty for EFT/B Test	: 3.84% kV
Uncertainty for Surge Test	: 0.53% kV
Uncertainty for C/S Test	: 1.45dB (Using CDN Test) 2.37dB (Using EM Clamp Test)
Uncertainty for DIPS Test	: 2.12% V
Uncertainty for R/S Test	: 2.10dB(80 MHz-200 MHz) 2.36dB(200 MHz-1000 MHz) 2.57dB(1000 MHz-6000 MHz)

3. MEASURING DEVICE AND TEST EQUIPMENT

3.1. For Power Line Conducted Emission Measurement

Equ. No.	Equipment	Manufacturer	Model No.	Serial No.	Last Cal.	Cal. Interval
ENE-002	EMI Test Receiver	Rohde & Schwarz	ESCI	101107	July 07, 2022	1 Year
ENE-158	L.I.S.N	Rohde & Schwarz	NNLK 8129	0373	Nov. 18, 2022	1 Year
ENE-004	L.I.S.N	Schwarzbeck	NSLK 8126	8126-462	July 07, 2022	1 Year
ENE-006	Pulse Limiter	MTS-systemtechnik	IMP-136	2611115-001-0033	July 07, 2022	1 Year
ENE-278	RF Switching unit	HTEC	HRSU	222101	August 22, 2022	1 Year
ENE-083	RF Cable	Hubber Suhner/Swiss	CBL-RE-3	/	April 07, 2022	1 Year

3.2. For Conducted Emissions at Telecommunications/network port Measurement

Equ. No.	Equipment	Manufacturer	Model No.	Serial No.	Last Cal.	Cal. Interval
ENE-002	EMI Test Receiver	Rohde & Schwarz	ESCI	101107	July 07, 2022	1 Year
ENE-067	I.S.N	Tsetq	ISNT8	51926	Dec. 29, 2022	1 Year
ENE-068	I.S.N	Tsetq	ISNT8-Cat 6	50583	Dec. 29, 2022	1 Year
ENE-159	Pulse Limiter	Schwarzbeck	VTSD 9561F-N	0929	Nov. 18, 2022	1 Year
ENE-278	RF Switching unit	HTEC	HRSU	222101	August 22, 2022	1 Year
ENE-162-1	RF Cable	TIMES	2M(N-N)	605236-0001	July 01, 2022	1 Year

3.3. For Radiated Emission Measurement (Up to 1 GHz)

Equ. No.	Equipment	Manufacturer	Model No.	Serial No.	Last Cal.	Cal. Interval
ENE-185	EMI Test Receiver	R&S	ESR7	102480	May 18, 2022	1 Year
ENE-190	Antenna multiple	Schwarzbeck	VULB 9163	01499	May 21, 2022	2 Year
ENE-195	Pre-Amplifier	JS Denki	PA09K03-40	JSPA21019	May 18, 2022	1 Year
ENE-204	Low frequency notch filterRf switching	JS Denki	JSDSW-F	JSDSW2211 D02	May 27, 2022	1 Year
ENE-279-1	RF cable	Rosenberger	L17-C001-7000	/	June 01, 2022	1 Year
ENE-279-2	RF cable	Rosenberger	L17-C001-3500	/	June 01, 2022	1 Year
ENE-279-3	RF cable	Rosenberger	L17-C001-1500	/	June 01, 2022	1 Year
ENE-279-4	RF cable	Rosenberger	/	/	June 01, 2022	1 Year
ENE-279-5	RF cable	Rosenberger	/	/	June 01, 2022	1 Year
ENE-279-6	RF cable	Rosenberger	L08-C446-1500	/	June 01, 2022	1 Year

3.4. For Radiated Emission Measurement (Above 1 GHz)

Equ. No.	Equipment	Manufacturer	Model No.	Serial No.	Last Cal.	Cal. Interval
ENE-171	EXA Signal Analyzer	KEYSIGHT	N9010B	MY60242467	March 01, 2022	1 Year
ENE-191	Horn antenna	Schwarzbeck	BBHA 9120 D	02588	May 21, 2022	2 Year
ENE-198	Pre-amplifier	JS Denki	PA0118-50	JSPA21022	May 18, 2022	1 Year
ENE-193	Horn antenna	Schwarzbeck	BBHA 9170	01190	May 21, 2022	2 Year
ENE-199	Pre-amplifier	JS Denki	PA1840-55	JSPA21023	May 18, 2022	1 Year
ENE-281-1	RF cable	Rosenberger	LA2-C125-3500	/	June 01, 2022	1 Year
ENE-281-2	RF cable	Rosenberger	LA2-C125-1500	/	June 01, 2022	1 Year
ENE-281-3	RF cable	Rosenberger	LU7-C1511-1200	/	June 01, 2022	1 Year
ENE-285-1	RF cable	Rosenberger	LA2-C199-6500	/	June 01, 2022	1 Year
ENE-290-1	RF cable	Schwarzbeck	LA1-C006-4000	/	June 01, 2022	1 Year
ENE-206	High frequency notch filterRf switching	JS Denki	JSDSW-F	202083582	May 27, 2022	1 Year

3.5. For Harmonic Current/Flicker Measurement

Equ. No.	Equipment	Manufacturer	Model No.	Serial No.	Last Cal.	Cal. Interval
ENE-157	Harmonic/ flicker analyzer	PACIFIC	ECTS2-3300 Z-M18012	550128	Nov. 18, 2022	1 Year
ENE-157-1	AC Power source	PACIFIC	330AZX-CE	140250014	Nov. 18, 2022	1 Year

3.6. For Electrostatic Discharge Immunity Test

Equ. No.	Equipment	Manufacturer	Model No.	Serial No.	Last Cal.	Cal. Interval
ENE-139	ESD Tester	TESEQ	NSG 437	1732	Nov. 30, 2022	1 Year

3.7. For RF Strength Susceptibility Test

Equ. No.	Equipment	Manufacturer	Model No.	Serial No.	Last Cal.	Cal. Interval
ENE-173	RF Signal generator	Keysight	N5171B	MY61252820	April 28, 2022	1 Year
ENE-174	SW-RF	JS Denki	JSDSW-BS0 2	JSDSW2120 D01	April 28, 2022	1 Year
ENE-175	Power Amplifier	Vectawave	VBA 1000-600c	132035	April 28, 2022	1 Year
ENE-176	Power Amplifier	Vectawave	VBA 1060-200	132120	April 28, 2022	1 Year
ENE-177	Directional couplers	Bonn	BDC 0810-50/150 0	2129259-01	April 28, 2022	1 Year
ENE-178	Directional couplers	Bonn	BDC 1060-40/500	2129304-03	April 28, 2022	1 Year
ENE-179	Multilayer periodic antenna	Schwarzbeck	STLP9129-7/ 16	03043	April 28, 2022	1 Year
ENE-180	RF cable	Times	LMR600-UF- 4M	611747-0001	April 28, 2022	1 Year
ENE-180-1	RF cable	Times	LMR600-UF- 1.5M	/	April 28, 2022	1 Year
ENE-181	RF cable	Times	LMR600-UF- 4M	611748-0001	April 28, 2022	1 Year
ENE-181-1	RF cable	Times	LMR600-UF- 1.5M	/	April 28, 2022	1 Year
ENE-182	power meter	Lumiloop	LSPM	86	April 28, 2022	1 Year

3.8. For Electrical Fast Transient /Burst Immunity Test

Equ. No.	Equipment	Manufacturer	Model No.	Serial No.	Last Cal.	Cal. Interval
ENE-011	Burst Tester	HAEFELY	PEFT4010	173964	July 07, 2022	1 Year
ENE-012	Coupling Clamp	HAEFELY	IP-4A	147399	July 07, 2022	1 Year
ENE-168	Coupling and Decoupling Network Three Phase	HAEFELY	FP-EFT 32M	190170	Dec. 29, 2022	1 Year

3.9. For Surge Immunity Test

Equ. No.	Equipment	Manufacturer	Model No.	Serial No.	Last Cal.	Cal. Interval
ENE-097-1	Combination Wave Generator	HTEC	HCWG 100	204303	Nov. 18, 2022	1 Year
ENE-097-2	Three Phase Coupling/Decoupling Network	HTEC	HCOUPLER 30S	204103	Nov. 18, 2022	1 Year
ENE-097-3	High Pressure Option	HTEC	Options-10K DC	/	Nov. 18, 2022	1 Year
ENE-097-4	40 ohm Impedance	HTEC	Options-40ohm	/	Nov. 18, 2022	1 Year
ENE-097-5	10 ohm Impedance	HTEC	Options-10ohm	/	Nov. 18, 2022	1 Year
ENE-097-6	Combination Wave Generator	HTEC	HTSG 70	204304	Nov. 18, 2022	1 Year
ENE-097-7	Coupling Network	HTEC	HCN 8	204901	Nov. 18, 2022	1 Year
ENE-097-8	Decoupling Network	HTEC	HDEC 8	204902	Nov. 18, 2022	1 Year
ENE-097-9	Isolated Power Supply	HTEC	SBK-30KVA	/	Nov. 18, 2022	1 Year

3.10. For Injected Current Susceptibility Test

Equ. No.	Equipment	Manufacturer	Model No.	Serial No.	Last Cal.	Cal. Interval
ENE-057	Simulator	SCHLODER	CDG-6000-7 5	126B1404/20 16	July 07, 2022	1 Year
ENE-058	CDN	SCHLODER	CDN-M2+3	A2210415/20 16	July 07, 2022	1 Year
ENE-056	Attenuator	SCHLODER	6dB 100W	HA1615	July 07, 2022	1 Year
ENE-098	Current Injection Probe	SCHLODER	CDN BCI-P1	19102314-01 01	Nov. 18, 2022	1 Year
ENE-099	EM-clamp	SCHLODER	CDN EMCL-20	20102817-01 03	Nov. 18, 2022	1 Year
ENE-160	Three phase CDN	SCHLODER	CDN M3-L32 HV	10749-1	Nov. 18, 2022	1 Year
ENE-160-1	Three phase CDN	SCHLODER	CDN M5-N32 HV	10751-1	Nov. 18, 2022	1 Year
ENE-160-2	Three phase CDN	SCHLODER	CDN M4-32 HV	10750-1	Nov. 18, 2022	1 Year
ENE-160-3	Three phase CDN	SCHLODER	CDN M4-32A	10982-1	May 18, 2022	1 Year

3.11. For Voltage Dips and Interruptions Test

Equ. No.	Equipment	Manufacturer	Model No.	Serial No.	Last Cal.	Cal. Interval
ENE-055	Dips Tester	HTEC	HPFS161P	164901	July 07, 2022	1 Year
ENE-055	AC Power source	HTEC	HV1P16T	164902	July 07, 2022	1 Year

4. CONDUCTED EMISSIONS FROM THE AC MAINS POWER PORTS

4.1. Block Diagram of Test Setup

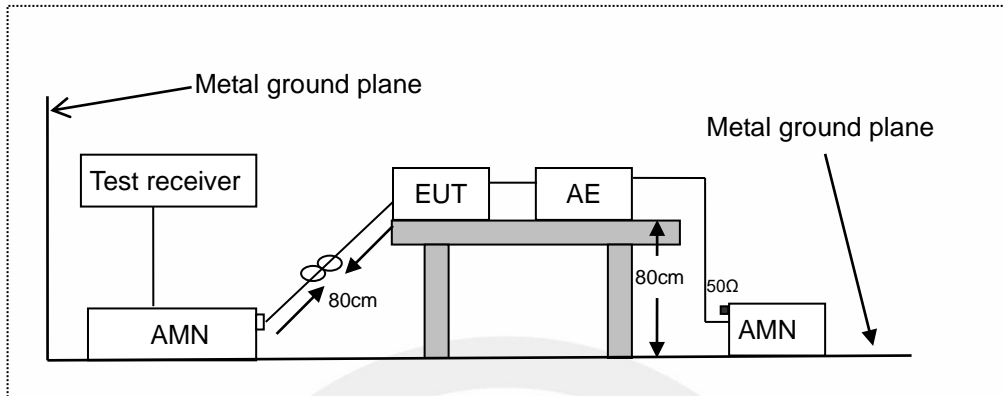

AMN: Artificial Mains Network
 AE: Associated equipment
 EUT: Equipment under test

4.2. Limits

EN 55032, Class B, Table A.10

Frequency range MHz	Coupling device (see Table A.8)	Detector type / bandwidth	Class B limits dB(μV)
0.15 to 0.5	AMN	Quasi Peak / 9 kHz	66 to 56
0.5 to 5			56
5 to 30			60
0.15 to 0.5	AMN	Average / 9 kHz	56 to 46
0.5 to 5			46
5 to 30			50

4.3. Test Procedure

The EUT was placed on a desk 0.8 m height from the metal ground plane and 0.4 m from the conducting wall of the shielding room and it was kept at least 0.8 m from any other grounded conducting surface. The size of the table will nominally be 1.5 m x1.0 m.

The rear of the arrangement shall be flush with the back of the supporting tabletop unless that would not be possible or typical of normal use.

All units of equipment forming the system under test (includes the EUT as well as connected peripherals and associated equipment or devices) shall be arranged such that a nominal 0.1 m separation is achieved between the neighboring units.

Connect EUT to the power mains through a artificial mains network (AMN). Where the mains cable supplied by the manufacturer is longer than 1 m, the excess should be folded at the centre into a bundle no longer than 0.4 m, so that its length is shortened to 1 m.

All the support units are connecting to the other AMN.

The AMN provides 50 ohm coupling impedance for the measuring instrument.

The CISPR states that the AMN with 50 ohm and 50 microhenry should be used.

Both sides of AC line were checked for maximum conducted interference.

The frequency range from 150 kHz to 30 MHz was sweep.

Set the test-receiver system to quasi peak detect function and average detect function, and to measure the conducted emissions values.

Test results were obtained from the following equation:

Measurement (dB μ V) = Correct Factor (dB) + Reading (dB μ V)

Over (dB) = Measurement (dB μ V) - Limit (dB μ V)

4.4. Measuring Results

Pass.

Please refer to the following pages.

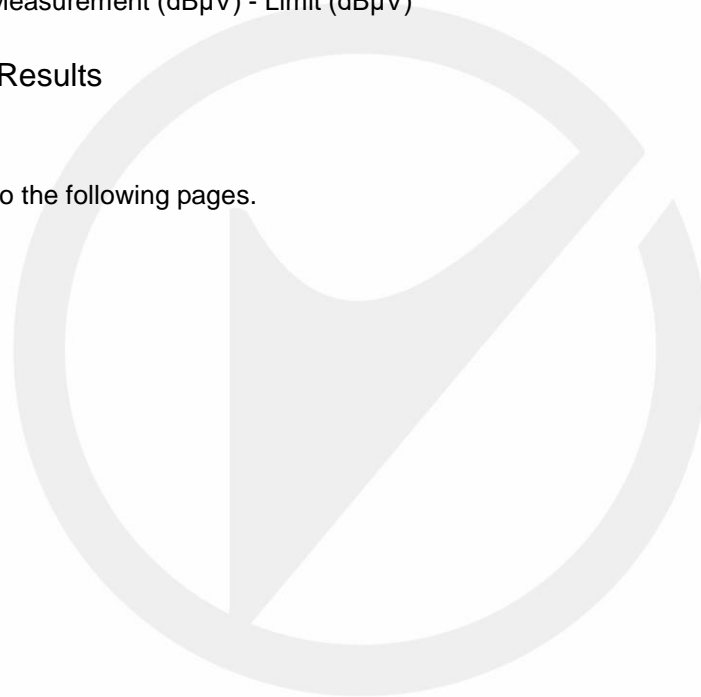

Project Information			
Mode:	WIFI	Voltage:	AC 230V/50Hz
Environment:	Temp: 25°C; Humi:52%	Engineer:	Allen Tang

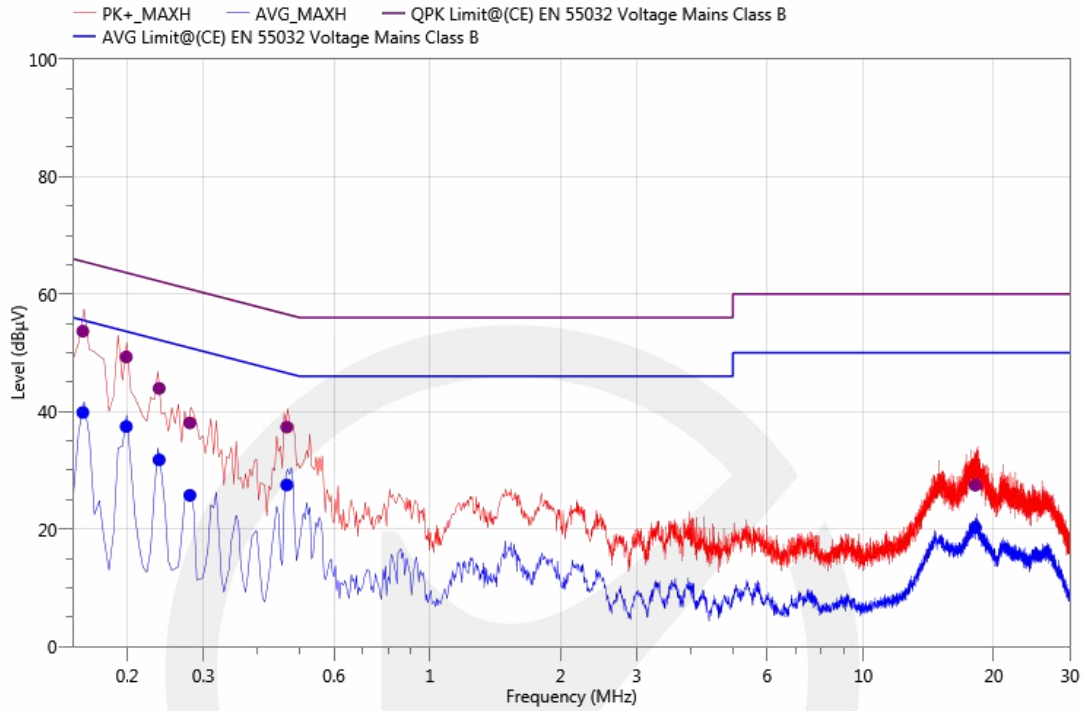

Freq. (MHz)	Reading (dBµV)	Meas. (dBµV)	Limit (dBµV)	Margin (dB)	Det.	Line	PE	Corr. (dB)	Verdict
0.16	43.60	53.68	65.57	11.89	QPK	N	GND	10.08	Pass
0.16	29.75	39.83	55.57	15.74	AVG	N	GND	10.08	Pass
0.20	39.19	49.31	63.65	14.34	QPK	N	GND	10.12	Pass
0.20	27.32	37.44	53.65	16.21	AVG	N	GND	10.12	Pass
0.24	33.81	43.94	62.20	18.26	QPK	N	GND	10.13	Pass
0.24	21.65	31.78	52.20	20.42	AVG	N	GND	10.13	Pass
0.28	27.92	38.07	60.85	22.78	QPK	N	GND	10.15	Pass
0.28	15.58	25.73	50.85	25.12	AVG	N	GND	10.15	Pass
0.47	27.25	37.35	56.57	19.22	QPK	N	GND	10.1	Pass
0.47	17.39	27.49	46.57	19.08	AVG	N	GND	10.1	Pass
18.13	16.34	27.47	60.00	32.53	QPK	N	GND	11.13	Pass
18.13	9.11	20.24	50.00	29.76	AVG	N	GND	11.13	Pass

Project Information			
Mode:	WIFI	Voltage:	AC 230V/50Hz
Environment:	Temp: 25°C; Humi:52%	Engineer:	Allen Tang

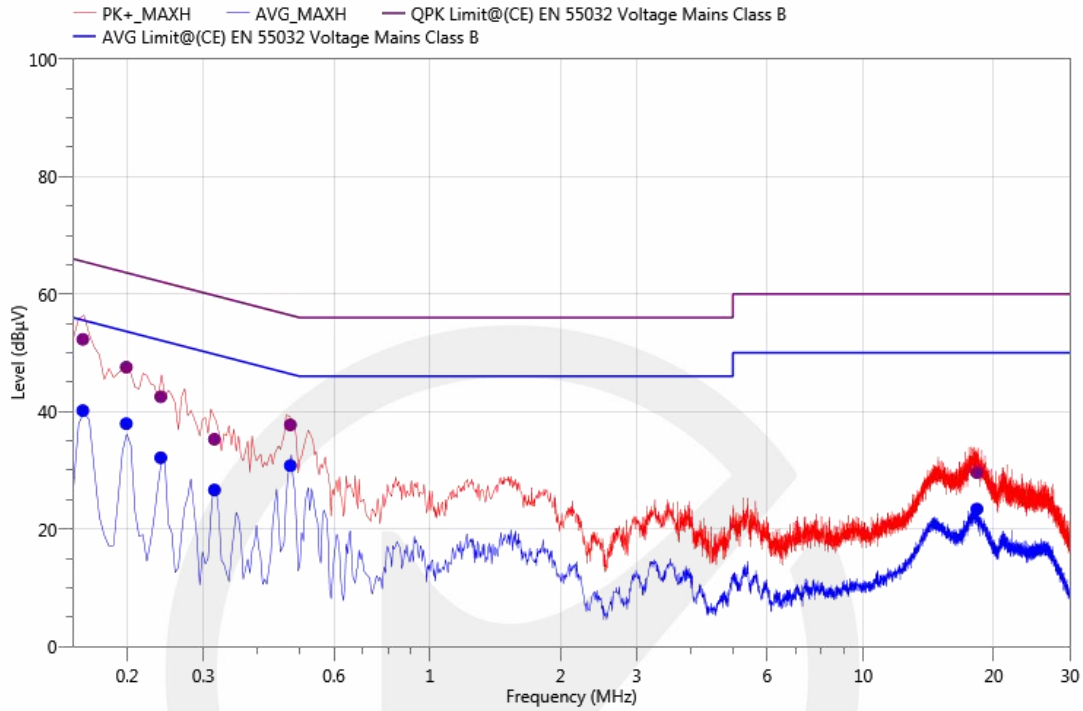

Freq. (MHz)	Reading (dBµV)	Meas. (dBµV)	Limit (dBµV)	Margin (dB)	Det.	Line	PE	Corr. (dB)	Verdict
0.16	42.24	52.30	65.57	13.27	QPK	L1	GND	10.06	Pass
0.16	30.10	40.16	55.57	15.41	AVG	L1	GND	10.06	Pass
0.20	37.42	47.55	63.65	16.1	QPK	L1	GND	10.13	Pass
0.20	27.80	37.93	53.65	15.72	AVG	L1	GND	10.13	Pass
0.24	32.40	42.52	62.13	19.61	QPK	L1	GND	10.12	Pass
0.24	22.01	32.13	52.13	20	AVG	L1	GND	10.12	Pass
0.32	25.08	35.28	59.76	24.48	QPK	L1	GND	10.2	Pass
0.32	16.44	26.64	49.76	23.12	AVG	L1	GND	10.2	Pass
0.48	27.53	37.73	56.41	18.68	QPK	L1	GND	10.2	Pass
0.48	20.59	30.79	46.41	15.62	AVG	L1	GND	10.2	Pass
18.29	18.57	29.60	60.00	30.4	QPK	L1	GND	11.03	Pass
18.29	12.36	23.39	50.00	26.61	AVG	L1	GND	11.03	Pass

Project Information			
Mode:	WIRED	Voltage:	AC 230V/50Hz
Environment:	Temp: 25°C; Humi:52%	Engineer:	Allen Tang

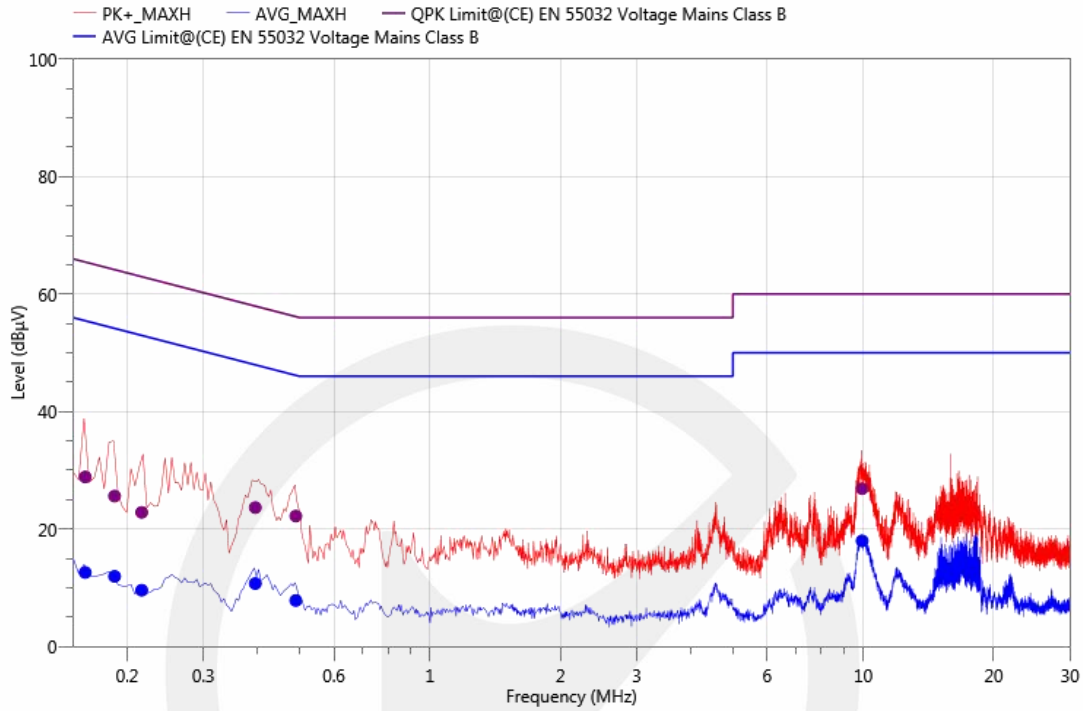

Freq. (MHz)	Reading (dBµV)	Meas. (dBµV)	Limit (dBµV)	Margin (dB)	Det.	Line	PE	Corr. (dB)	Verdict
0.16	18.80	28.86	65.46	36.6	QPK	L1	GND	10.06	Pass
0.16	2.53	12.59	55.46	42.87	AVG	L1	GND	10.06	Pass
0.19	15.49	25.60	64.17	38.57	QPK	L1	GND	10.11	Pass
0.19	1.82	11.93	54.17	42.24	AVG	L1	GND	10.11	Pass
0.22	12.70	22.83	62.97	40.14	QPK	L1	GND	10.13	Pass
0.22	-0.56	9.57	52.97	43.4	AVG	L1	GND	10.13	Pass
0.40	13.12	23.65	57.96	34.31	QPK	L1	GND	10.53	Pass
0.40	0.18	10.71	47.96	37.25	AVG	L1	GND	10.53	Pass
0.49	12.06	22.20	56.17	33.97	QPK	L1	GND	10.14	Pass
0.49	-2.32	7.82	46.17	38.35	AVG	L1	GND	10.14	Pass
9.94	16.15	26.87	60.00	33.13	QPK	L1	GND	10.72	Pass
9.94	7.26	17.98	50.00	32.02	AVG	L1	GND	10.72	Pass

Project Information			
Mode:	WIRED	Voltage:	AC 230V/50Hz
Environment:	Temp: 25°C; Humi:52%	Engineer:	Allen Tang

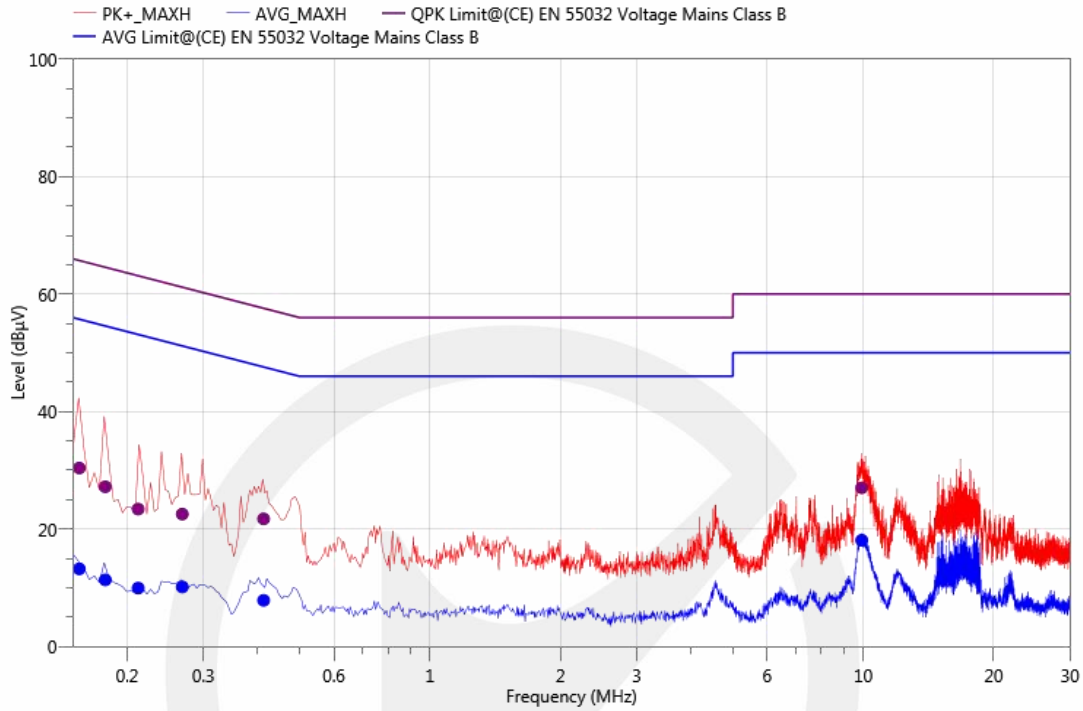

Freq. (MHz)	Reading (dBµV)	Meas. (dBµV)	Limit (dBµV)	Margin (dB)	Det.	Line	PE	Corr. (dB)	Verdict
0.16	20.30	30.38	65.73	35.35	QPK	N	GND	10.08	Pass
0.16	3.13	13.21	55.73	42.52	AVG	N	GND	10.08	Pass
0.18	17.09	27.19	64.58	37.39	QPK	N	GND	10.1	Pass
0.18	1.23	11.33	54.58	43.25	AVG	N	GND	10.1	Pass
0.21	13.27	23.39	63.13	39.74	QPK	N	GND	10.12	Pass
0.21	-0.19	9.93	53.13	43.2	AVG	N	GND	10.12	Pass
0.27	12.39	22.54	61.18	38.64	QPK	N	GND	10.15	Pass
0.27	-0.02	10.13	51.18	41.05	AVG	N	GND	10.15	Pass
0.41	11.63	21.73	57.59	35.86	QPK	N	GND	10.1	Pass
0.41	-2.25	7.85	47.59	39.74	AVG	N	GND	10.1	Pass
9.92	16.25	27.02	60.00	32.98	QPK	N	GND	10.77	Pass
9.92	7.31	18.08	50.00	31.92	AVG	N	GND	10.77	Pass

5. ASYMMETRIC MODE CONDUCTED EMISSIONS AT WIRED NETWORK PORTS

5.1. Block Diagram of Test Setup

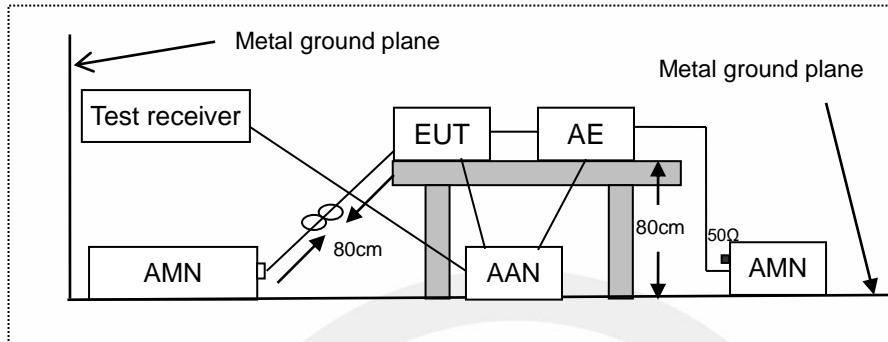

AMN: Artificial mains network
 AE: Associated equipment
 EUT: Equipment under test
 AAN: Asymmetric artificial network

5.2. Limits

EN 55032, Class B, Table A.12

Frequency range (MHz)	Coupling device (see Table A.8)	Detector type / bandwidth	Class B voltage limits dB(μV)	Class B current limits dB(μA)
0.15 to 0.5	AAN	Quasi Peak / 9 kHz	84 to 74	N/A
0.5 to 30			74	
0.15 to 0.5	AAN	Average / 9 kHz	74 to 64	
0.5 to 30			64	
0.15 to 0.5	CVP and current probe	Quasi Peak / 9 kHz	84 to 74	40 to 30
0.5 to 30			74	30
0.15 to 0.5	CVP and current probe	Average / 9 kHz	74 to 64	30 to 20
0.5 to 30			64	20
0.15 to 0.5	Current Probe	Quasi Peak / 9 kHz	N/A	40 to 30
0.5 to 30				30
0.15 to 0.5	Current Probe	Average / 9 kHz		30 to 20
0.5 to 30				20

5.3. Test Procedure

The EUT is put on the plane 0.8m high above the ground by insulating support and connected to the AC mains through artificial mains network(AMN) or connected to the wired network port through an asymmetric artificial network(AAN). AMN provided a 50ohm coupling impedance for the tested equipment AC mains port, ANN provided a common mode (asymmetric mode) impedance of 150 Ω to the wired network port under test. Both sides of AC line and the wired network line are investigated to

find out the maximum conducted emission according to the EN 55032 regulations during conducted emission measurement.

The bandwidth of the receiver is set at 9 kHz in 150 kHz~30 MHz. The frequency range from 150 kHz to 30 MHz is investigated.

Test results were obtained from the following equation:

Measurement (dB μ V) = Correct Factor (dB) + Reading (dB μ V)

Over (dB) = Measurement (dB μ V) - Limit (dB μ V)

5.4. Measuring Results

Pass.

Please refer to the following pages.



Project Information			
Mode:	WIRED	Voltage:	AC 230V/50Hz
Environment:	Temp: 25°C; Humi:52%	Engineer:	Allen Tang

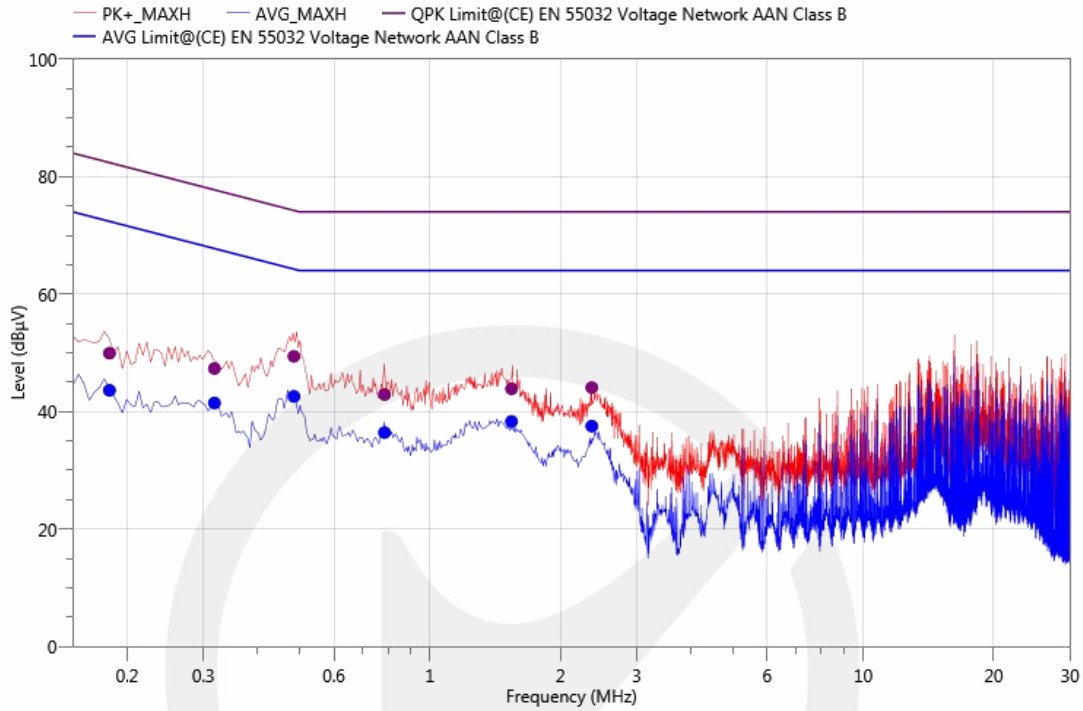

Freq. (MHz)	Reading (dBµV)	Meas. (dBµV)	Limit (dBµV)	Margin (dB)	Det.	Line	PE	Corr. (dB)	Verdict
0.18	30.20	49.93	82.39	32.46	QPK	N	GND	19.73	Pass
0.18	23.88	43.61	72.39	28.78	AVG	N	GND	19.73	Pass
0.32	27.67	47.33	77.76	30.43	QPK	N	GND	19.66	Pass
0.32	21.80	41.46	67.76	26.3	AVG	N	GND	19.66	Pass
0.49	29.78	49.40	74.25	24.85	QPK	N	GND	19.62	Pass
0.49	22.96	42.58	64.25	21.67	AVG	N	GND	19.62	Pass
0.79	23.42	42.90	74.00	31.1	QPK	N	GND	19.48	Pass
0.79	16.94	36.42	64.00	27.58	AVG	N	GND	19.48	Pass
1.54	24.47	43.88	74.00	30.12	QPK	N	GND	19.41	Pass
1.54	18.91	38.32	64.00	25.68	AVG	N	GND	19.41	Pass
2.36	24.73	44.08	74.00	29.92	QPK	N	GND	19.35	Pass
2.36	18.17	37.52	64.00	26.48	AVG	N	GND	19.35	Pass

6. RADIATED EMISSION MEASUREMENT (UP TO 1GHz)

6.1. Block Diagram of Test Setup

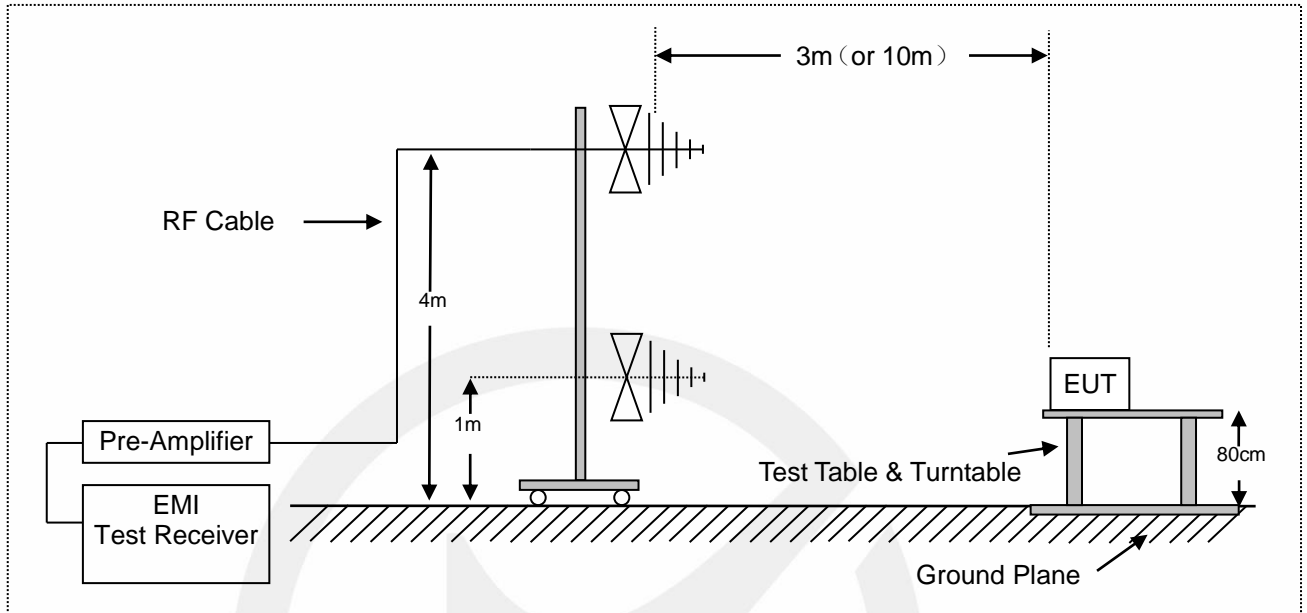

6.2. Radiated Limit

EN 55032, Class B, Table A.4

Frequency range MHz	Measurement			Class B limits dB(μ V/m)
	Facility	Distance (m)	Detector type / bandwidth	
30 to 230	OATS/SAC	10	Quasi Peak / 120 kHz	30
230 to 1 000				37
30 to 230	OATS/SAC	3		40
230 to 1 000				47

6.3. Test Procedure

The EUT was placed on a non-conductive table whose total height equaled 80cm. All units of equipment forming the system under test (includes the EUT as well as connected peripherals and associated equipment or devices) shall be arranged such that a nominal 0.1 m separation is achieved between the neighboring units. Where the mains cable supplied by the manufacturer is longer than 1 m, the excess should be folded at the centre into a bundle no longer than 0.4 m, so that its length is shortened to 1 m.

The EUT was set 3 meters (or 10 meters) away from the receiving antenna that was mounted on a non-conductive mast. The antenna can move up and down between 1 to 4 meters to find out the maximum emission level.

The turntable can rotate 360 degree to determine the position of the maximum emission level.

The initial testing identified the frequency that has the highest disturbance relative to the limit while operating the EUT in typical modes of operation and cable positions in a test setup representative of typical system configuration.

The identification of the frequency of highest emission with respect to the limit was found by investigating emissions at a number of significant frequencies. The probable frequency of maximum emission had been found and that the associated cable and EUT configuration and mode of operation had been identified.

The bandwidth of the Receiver is set at 120 kHz.

Test results were obtained from the following equation:

Measurement (dB μ V) = Correct Factor (dB) + Reading (dB μ V)

Over (dB) = Measurement (dB μ V) - Limit (dB μ V)

6.4. Measuring Results

Pass.

Please refer to the following pages.

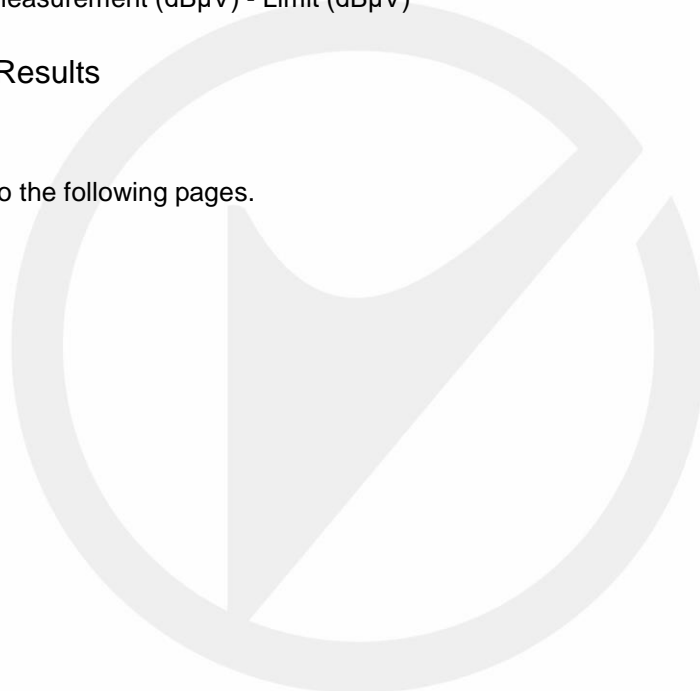

Project Information			
Mode:	WIFI	Voltage:	DC 5V
Environment:	Temp: 16°C Humi:58%	Engineer:	Jackson Xue

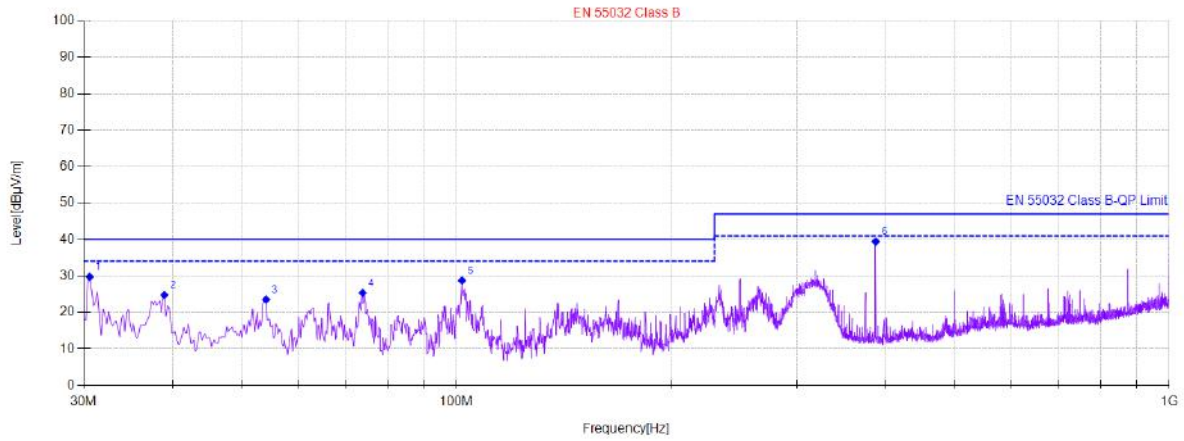

Final Data List

NO.	Freq. [MHz]	QP Reading [dBµV/m]	Factor [dB]	QP Value [dBµV/m]	QP Limit [dBµV/m]	QP Margin [dB]	Height [cm]	Angle [°]	Polarity	Verdict
1	30.5821	61.09	-31.35	29.74	40.00	10.26	100	339	Vertical	Pass
2	38.9258	55.46	-30.68	24.78	40.00	15.22	100	10	Vertical	Pass
3	54.0608	54.40	-30.89	23.51	40.00	16.49	100	227	Vertical	Pass
4	73.8528	58.38	-33.03	25.35	40.00	14.65	100	292	Vertical	Pass
5	101.794	60.20	-31.46	28.74	40.00	11.26	100	136	Vertical	Pass
6	387.419	65.92	-26.50	39.42	47.00	7.58	100	156	Vertical	Pass

Project Information			
Mode:	WIFI	Voltage:	DC 5V
Environment:	Temp: 16°C Humi:58%	Engineer:	Jackson Xue

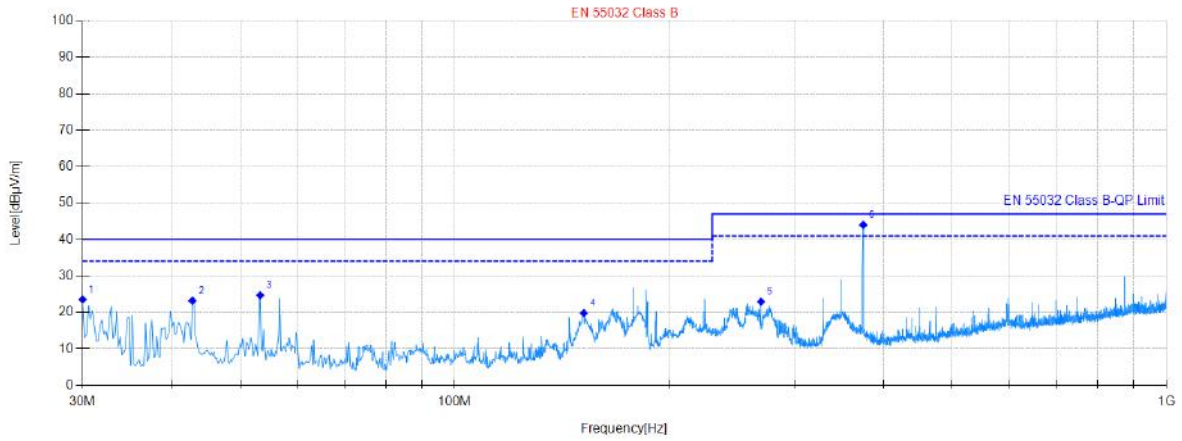

Final Data List

NO.	Freq. [MHz]	QP Reading [dBµV/m]	Factor [dB]	QP Value [dBµV/m]	QP Limit [dBµV/m]	QP Margin [dB]	Height [cm]	Angle [°]	Polarity	Verdict
1	30	54.95	-31.40	23.55	40.00	16.45	100	258	Horizontal	Pass
2	42.8066	53.50	-30.31	23.19	40.00	16.81	100	242	Horizontal	Pass
3	53.2847	55.46	-30.75	24.71	40.00	15.29	100	73	Horizontal	Pass
4	151.856	52.76	-32.97	19.79	40.00	20.21	100	305	Horizontal	Pass
5	269.443	51.77	-28.85	22.92	47.00	24.08	100	204	Horizontal	Pass
6	375.001	70.28	-26.28	44.00	47.00	3.00	100	336	Horizontal	Pass

Project Information			
Mode:	WIRED	Voltage:	DC 5V
Environment:	Temp: 16°C Humi:58%	Engineer:	Jackson Xue

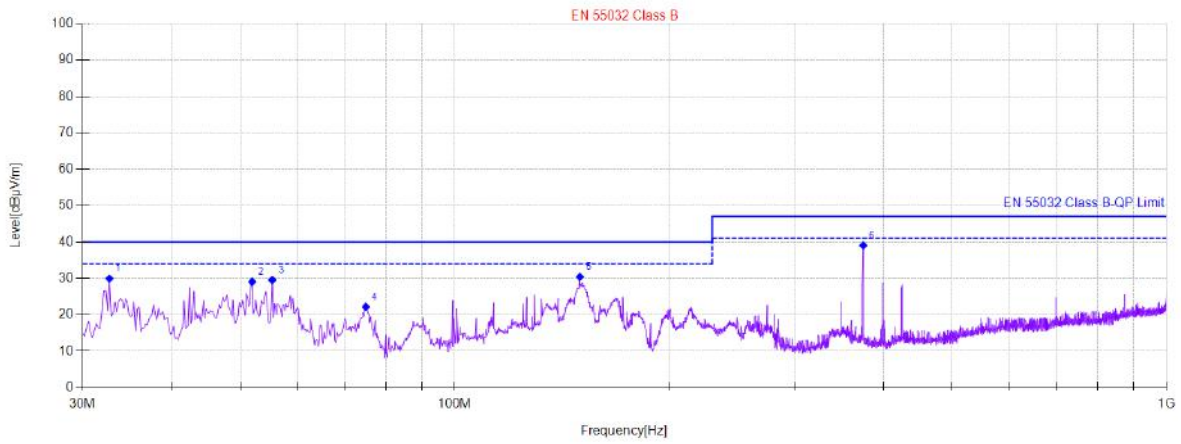

Final Data List

NO.	Freq. [MHz]	QP Reading [dBµV/m]	Factor [dB]	QP Value [dBµV/m]	QP Limit [dBµV/m]	QP Margin [dB]	Height [cm]	Angle [°]	Polarity	Verdict
1	32.7165	61.11	-31.18	29.93	40.00	10.07	100	207	Vertical	Pass
2	51.9264	59.59	-30.52	29.07	40.00	10.93	100	251	Vertical	Pass
3	55.4191	60.65	-31.12	29.53	40.00	10.47	100	152	Vertical	Pass
4	75.017	55.21	-33.02	22.19	40.00	17.81	100	227	Vertical	Pass
5	149.916	63.39	-32.97	30.42	40.00	9.58	100	336	Vertical	Pass
6	375.001	65.34	-26.28	39.06	47.00	7.94	100	264	Vertical	Pass

Project Information			
Mode:	WIRED	Voltage:	DC 5V
Environment:	Temp: 16°C Humi:58%	Engineer:	Jackson Xue

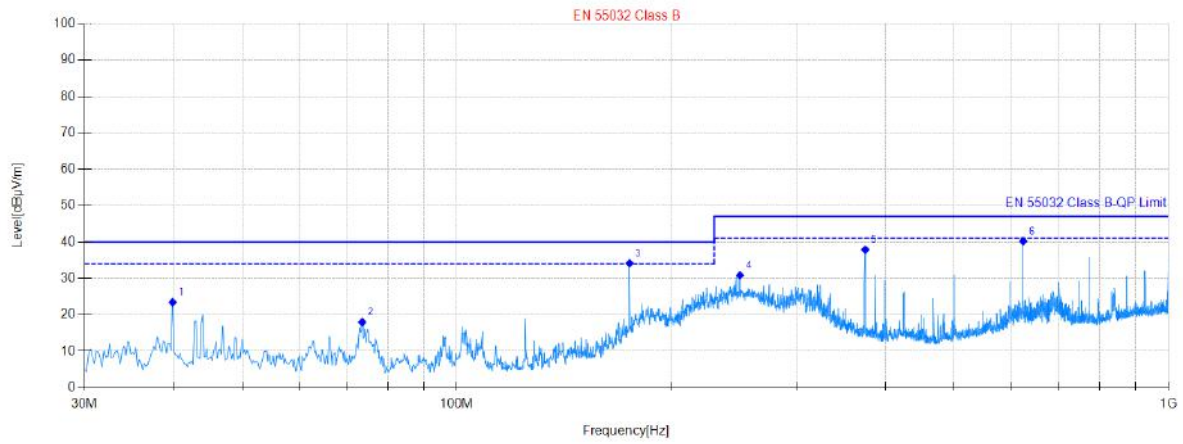

Final Data List										
NO.	Freq. [MHz]	QP Reading [dBµV/m]	Factor [dB]	QP Value [dBµV/m]	QP Limit [dBµV/m]	QP Margin [dB]	Height [cm]	Angle [°]	Polarity	Verdict
1	39.896	54.03	-30.60	23.43	40.00	16.57	100	234	Horizontal	Pass
2	73.6587	50.99	-33.04	17.95	40.00	22.05	100	18	Horizontal	Pass
3	174.947	66.49	-32.32	34.17	40.00	5.83	100	64	Horizontal	Pass
4	250.04	59.62	-28.77	30.85	47.00	16.15	100	269	Horizontal	Pass
5	375.001	64.17	-26.28	37.89	47.00	9.11	100	290	Horizontal	Pass
6	625.117	61.31	-21.08	40.23	47.00	6.77	100	121	Horizontal	Pass

7. RADIATED EMISSION MEASUREMENT (ABOVE 1GHz)

7.1. Block Diagram of Test Setup

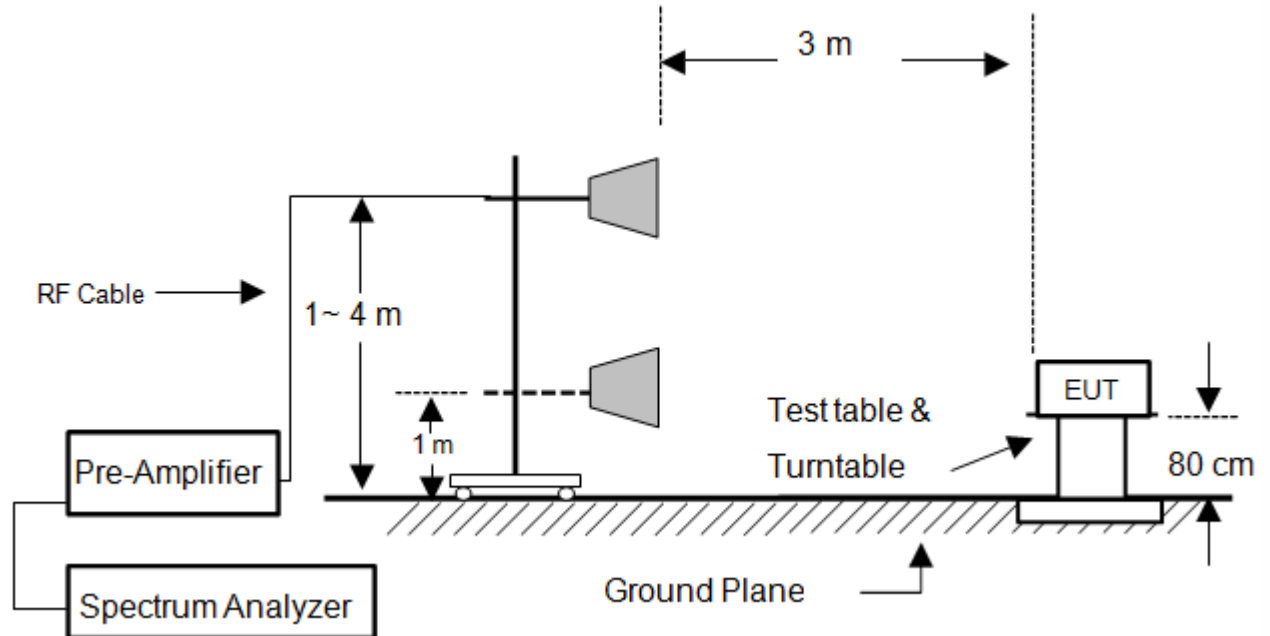

7.2. Radiated Limit

EN 55032, Class B, Table A.5

Frequency range (MHz)	Measurement			Class B limits dB(μ V/m)
	Facility	Distance (m)	Detector type/ bandwidth	
1000 to 6000	FSOATS	3	Average / 1 MHz	54
1000 to 6000			Peak / 1 MHz	74

Note: The highest internal source of an EUT is defined as the highest frequency generated or used within the EUT or on which the EUT operates or tunes. If the highest frequency of the internal sources of the EUT is less than 108 MHz, the measurement shall only be made up to 1 GHz. If the highest frequency of the internal sources of the EUT is between 108 MHz and 500 MHz the measurement shall only be made up to 2 GHz. If the highest frequency of the internal sources of the EUT is between 500 MHz and 1 GHz, the measurement shall only be made up to 5 GHz. If the highest frequency of the internal sources of the EUT is above 1 GHz, the measurement shall be made up to 5 times the highest frequency or 6 GHz, whichever is less.

7.3. Test Procedure

The EUT was placed on a non-conductive table whose total height equaled 80cm. All units of equipment forming the system under test (includes the EUT as well as connected peripherals and associated equipment or devices) shall be arranged such that a nominal 0.1 m separation is achieved between the neighboring units. Where the mains cable supplied by the manufacturer is longer than 1 m, the excess should be folded at the centre into a bundle no longer than 0.4 m, so that its length is shortened to 1 m.

The EUT was set 3 meters away from the receiving antenna that was mounted on a non-conductive mast. The antenna can move up and down between 1 to 4 meters to find out the maximum emission level.

The turntable can rotate 360 degree to determine the position of the maximum emission level.

The initial testing identified the frequency that has the highest disturbance relative to the limit while operating the EUT in typical modes of operation and cable positions in a test setup representative of typical system configuration.

The identification of the frequency of highest emission with respect to the limit was found by investigating emissions at a number of significant frequencies. The probable frequency of maximum emission had been found and that the associated cable and EUT configuration and mode of operation had been identified.

The frequency range above 1GHz the measuring instrument use RBW=1 MHz and VBW=3 MHz.

Test results were obtained from the following equation:

Measurement (dB μ V) =Correct Factor (dB) + Reading (dB μ V)

Over (dB) = Measurement (dB μ V) - Limit (dB μ V)

7.4. Measuring Results

Pass.

Please refer to the following pages.

Project Information			
Mode:	WIFI	Voltage:	DC 5V
Environment:	Temp: 16°C; Humi:48%	Engineer:	Jackson Xue

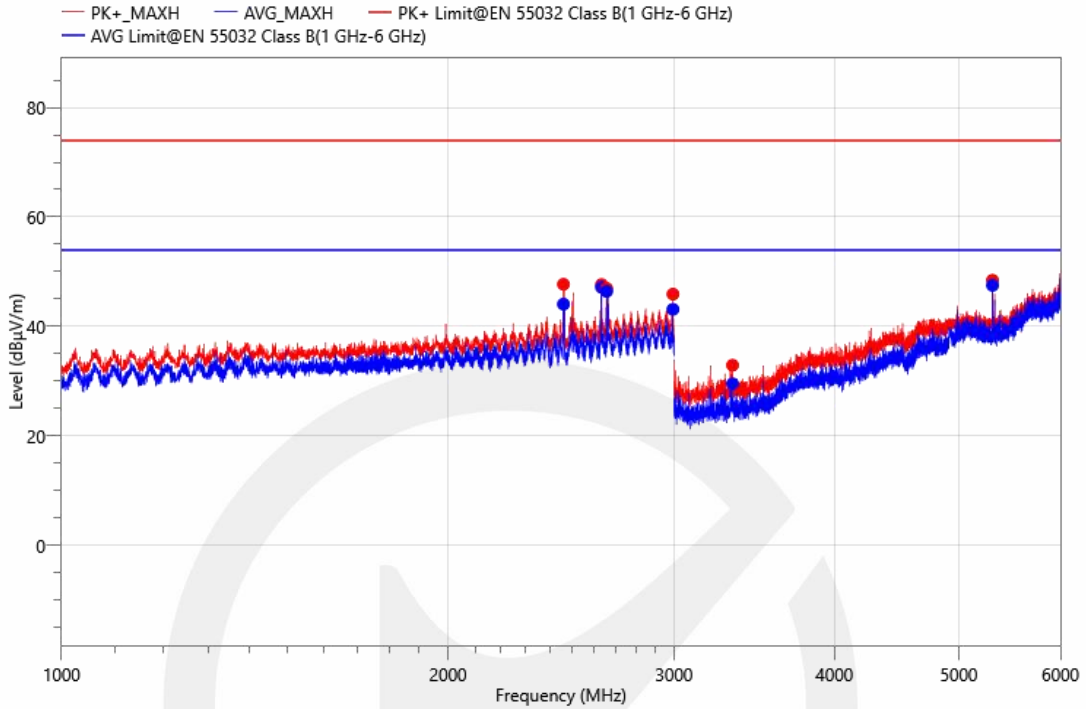

Freq. (MHz)	Reading (dBµV)	Meas. (dBµV/m)	Limit (dBµV/m)	Margin (dBµV/m)	Det.	Height (cm)	Pol.	Azimuth (deg)	Corr. (dB)	Verdict
2460.00	57.11	47.71	74.00	26.29	PK+	100.0	V	0.0	-9.4	Pass
2460.00	53.47	44.07	54.00	9.93	AVG	100.0	V	0.0	-9.4	Pass
2634.20	56.85	47.66	74.00	26.34	PK+	100.0	V	0.0	-9.19	Pass
2634.20	56.33	47.14	54.00	6.86	AVG	100.0	V	0.0	-9.19	Pass
2658.00	56.10	46.96	74.00	27.04	PK+	100.0	V	0.0	-9.14	Pass
2658.00	55.55	46.41	54.00	7.59	AVG	100.0	V	0.0	-9.14	Pass
2993.80	53.16	45.90	74.00	28.1	PK+	100.0	V	0.0	-7.26	Pass
2993.80	50.38	43.12	54.00	10.88	AVG	100.0	V	0.0	-7.26	Pass
3331.80	45.21	32.91	74.00	41.09	PK+	100.0	V	0.0	-12.3	Pass
3331.80	41.82	29.52	54.00	24.48	AVG	100.0	V	0.0	-12.3	Pass
5311.20	54.52	48.44	74.00	25.56	PK+	100.0	V	0.0	-6.08	Pass
5311.20	53.58	47.50	54.00	6.5	AVG	100.0	V	0.0	-6.08	Pass

Project Information			
Mode:	WIFI	Voltage:	DC 5V
Environment:	Temp: 16°C; Humi:48%	Engineer:	Jackson Xue

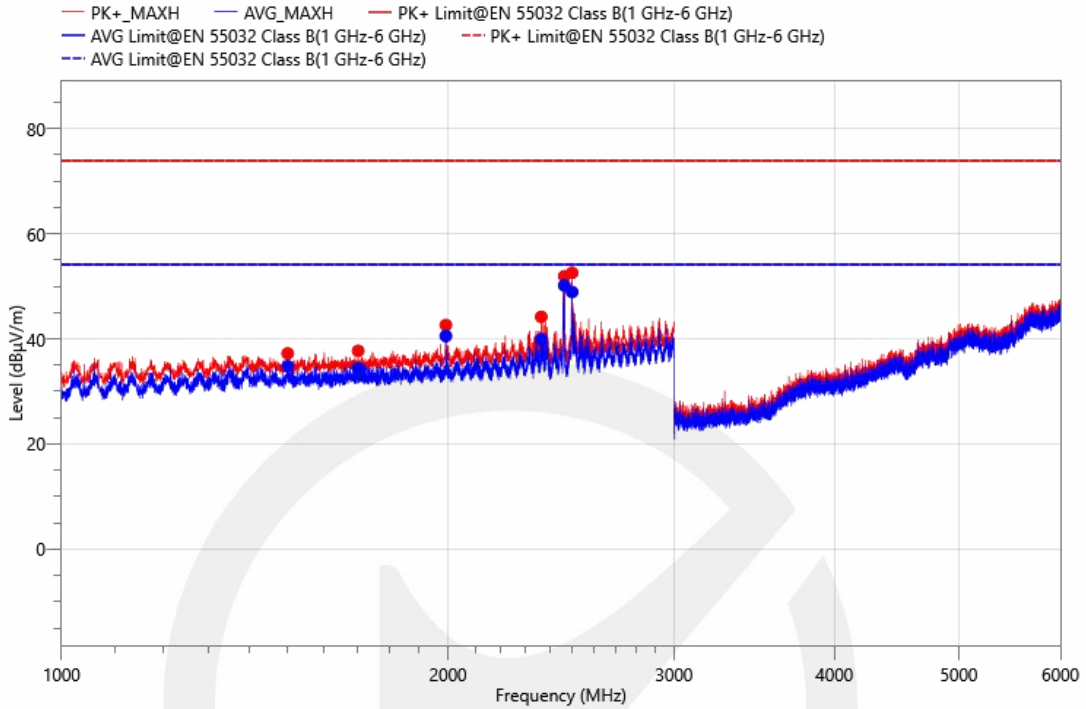

Freq. (MHz)	Reading (dBµV)	Meas. (dBµV/m)	Limit (dBµV/m)	Margin (dBµV/m)	Det.	Height (cm)	Pol.	Azimuth (deg)	Corr. (dB)	Verdict
1702.20	50.29	37.73	74.00	36.27	PK+	100.0	H	232.1	-12.56	Pass
1702.20	46.98	34.42	54.00	19.58	AVG	100.0	H	232.1	-12.56	Pass
1500.20	50.26	37.23	74.00	36.77	PK+	100.0	H	232.1	-13.03	Pass
1500.20	47.83	34.80	54.00	19.2	AVG	100.0	H	232.1	-13.03	Pass
1992.20	54.12	42.64	74.00	31.36	PK+	100.0	H	232.1	-11.48	Pass
1992.20	52.04	40.56	54.00	13.44	AVG	100.0	H	232.1	-11.48	Pass
2364.00	54.18	44.19	74.00	29.81	PK+	100.0	H	232.1	-9.99	Pass
2364.00	49.94	39.95	54.00	14.05	AVG	100.0	H	232.1	-9.99	Pass
2464.00	61.31	51.93	74.00	22.07	PK+	100.0	H	232.1	-9.38	Pass
2464.00	59.55	50.17	54.00	3.83	AVG	100.0	H	232.1	-9.38	Pass
2498.60	61.83	52.58	74.00	21.42	PK+	100.0	H	232.1	-9.25	Pass
2498.60	58.18	48.93	54.00	5.07	AVG	100.0	H	232.1	-9.25	Pass

Project Information			
Mode:	WIRED	Voltage:	DC 5V
Environment:	Temp: 16°C; Humi:50%	Engineer:	Jackson Xue

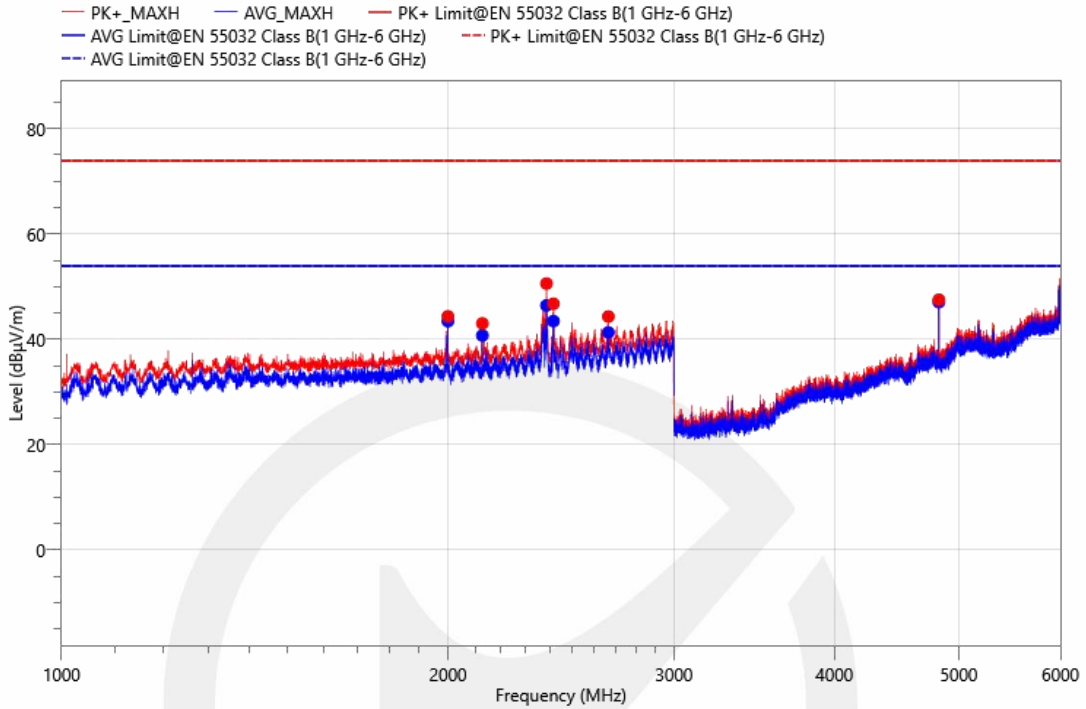

Freq. (MHz)	Reading (dBµV)	Meas. (dBµV/m)	Limit (dBµV/m)	Margin (dBµV/m)	Det.	Height (cm)	Pol.	Azimuth (deg)	Corr. (dB)	Verdict
1999.60	55.81	44.35	74.00	29.65	PK+	150.0	V	0.0	-11.46	Pass
1999.60	54.89	43.43	54.00	10.57	AVG	150.0	V	0.0	-11.46	Pass
2127.00	54.21	43.01	74.00	30.99	PK+	150.0	V	0.0	-11.2	Pass
2127.00	51.93	40.73	54.00	13.27	AVG	150.0	V	0.0	-11.2	Pass
2386.40	60.28	50.59	74.00	23.41	PK+	150.0	V	0.0	-9.69	Pass
2386.40	56.12	46.43	54.00	7.57	AVG	150.0	V	0.0	-9.69	Pass
2416.20	56.35	46.75	74.00	27.25	PK+	150.0	V	0.0	-9.6	Pass
2416.20	53.05	43.45	54.00	10.55	AVG	150.0	V	0.0	-9.6	Pass
2666.40	53.39	44.31	74.00	29.69	PK+	150.0	V	0.0	-9.08	Pass
2666.40	50.37	41.29	54.00	12.71	AVG	150.0	V	0.0	-9.08	Pass
4823.70	54.94	47.51	74.00	26.49	PK+	150.0	V	0.0	-7.43	Pass
4823.70	54.48	47.05	54.00	6.95	AVG	150.0	V	0.0	-7.43	Pass

Project Information			
Mode:	WIRED	Voltage:	DC 5V
Environment:	Temp: 16°C; Humi:50%	Engineer:	Jackson Xue

— PK+_MAXH — AVG_MAXH — PK+ Limit@EN 55032 Class B(1 GHz-6 GHz)
— AVG Limit@EN 55032 Class B(1 GHz-6 GHz) - - - PK+ Limit@EN 55032 Class B(1 GHz-6 GHz)
- - - AVG Limit@EN 55032 Class B(1 GHz-6 GHz)

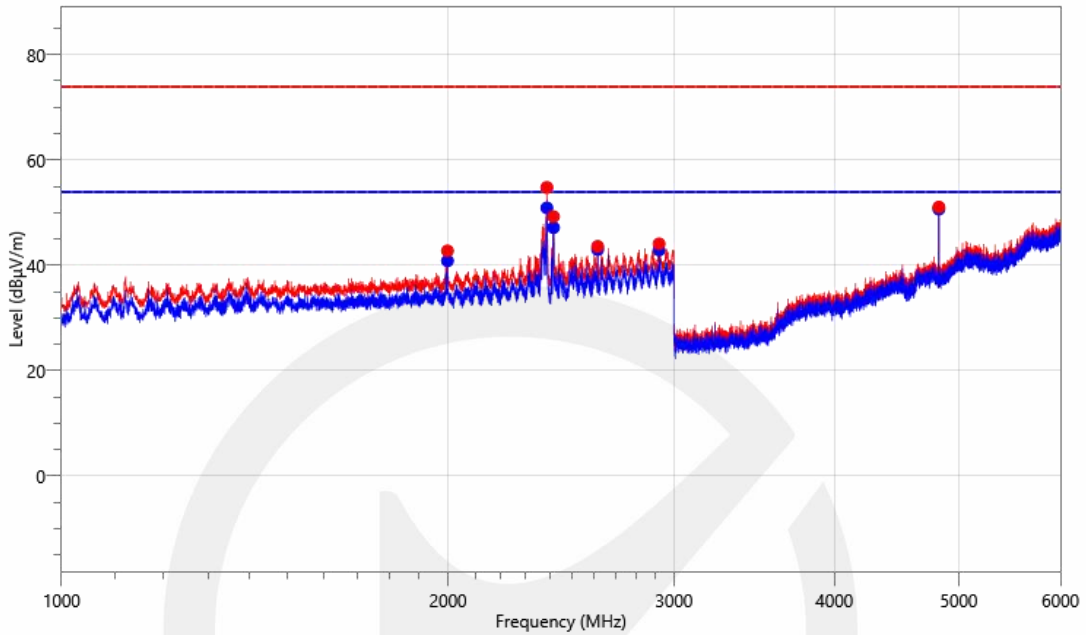

Freq. (MHz)	Reading (dBµV)	Meas. (dBµV/m)	Limit (dBµV/m)	Margin (dBµV/m)	Det.	Height (cm)	Pol.	Azimuth (deg)	Corr. (dB)	Verdict
1998.00	54.21	42.75	74.00	31.25	PK+	150.0	H	0.2	-11.46	Pass
1998.00	52.30	40.84	54.00	13.16	AVG	150.0	H	0.2	-11.46	Pass
2387.80	64.46	54.77	74.00	19.23	PK+	150.0	H	0.2	-9.69	Pass
2387.80	60.59	50.90	54.00	3.1	AVG	150.0	H	0.2	-9.69	Pass
2416.40	58.85	49.25	74.00	24.75	PK+	150.0	H	0.2	-9.6	Pass
2416.40	56.74	47.14	54.00	6.86	AVG	150.0	H	0.2	-9.6	Pass
2615.60	52.75	43.61	74.00	30.39	PK+	150.0	H	0.2	-9.14	Pass
2615.60	52.13	42.99	54.00	11.01	AVG	150.0	H	0.2	-9.14	Pass
2920.20	51.57	44.08	74.00	29.92	PK+	150.0	H	0.2	-7.49	Pass
2920.20	50.38	42.89	54.00	11.11	AVG	150.0	H	0.2	-7.49	Pass
4824.00	58.48	51.06	74.00	22.94	PK+	150.0	H	0.2	-7.42	Pass
4824.00	58.07	50.65	54.00	3.35	AVG	150.0	H	0.2	-7.42	Pass

8. HARMONIC CURRENT EMISSION MEASUREMENT

8.1. Block Diagram of Test Setup

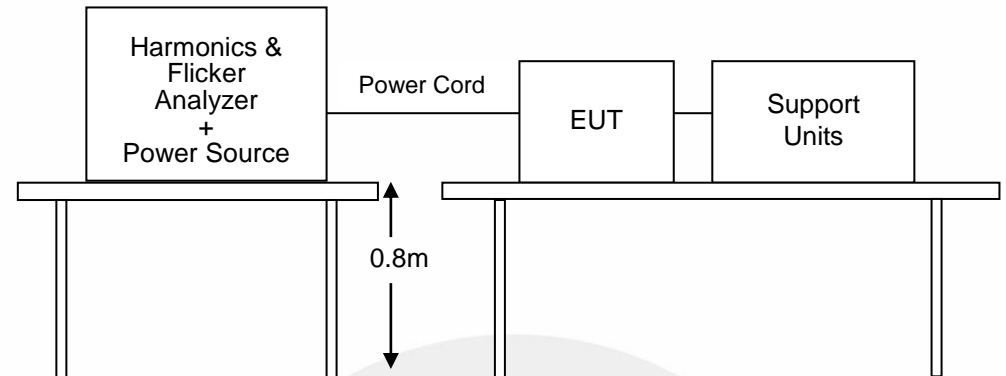

8.2. Standard Limits

EN IEC 61000-3-2, CLASS A

Harmonic current emissions evaluate the potential for the EUT to cause distortion on the AC power lines. It is applicable to electrical and electronic equipment having an input current ≤ 16 A per phase, and intended to be connected to public low-voltage distribution systems

Table 1 - Limits for Class A equipment

Harmonic order n	Maximum permissible harmonic current (A)
Odd harmonics	
3	2.30
5	1.14
7	0.77
9	0.40
11	0.33
13	0.21
$15 \leq n \leq 39$	$0.15 \frac{0.15}{n}$
Even harmonics	
2	1.08
4	0.43
6	0.30
$8 \leq n \leq 40$	$0.23 \frac{8}{n}$

8.3. Test Procedure

The measurement of harmonic currents shall be performed as follows: i. For each harmonic order, measure the 1.5 s smoothed r.m.s. harmonic current in each DFT time window as defined in EN / IEC 61000-4-7:2009. ii. Calculate the arithmetic average of the measured values from the DFT time windows, over the entire observation period Short cyclic ($T \text{ cycle} \leq 2.5 \text{ min}$). Because of synchronisation to meet the requirements for repeatability in 5%.

8.4. Test Results

Pass.

Please refer to the following pages.



EUT: Pocket WIFI+LAN(Pocket WIFI+LAN)
Test Standard: Test per IEC 61000-3-2 Ed. 5.1 : 2020
Test Class: (Class A Test) - No inter-harmonics
Test Result: **PASS - POHC Allowable**
Test Date: 2023/2/14
Start Time: 13:36:56
Stop Time: 13:39:36
Test Duration (min): 2.5
Environment: Temp: 24°C; Humi:42%
Source Qualification: Compliance with IEC 61000-3-2 Ed. 5.1 : 2020
Power Source Distortion: **OK**
Customer: Customer
Test By: Jo Liu
Comments: WIFI

General Test Data: (Phase A)

Vrms (Volts)/V-pk/V-CF:	219.41 / 309.5 / 1.411	Frequency (Hz):	50.0001
I _{rms} (Amps):	0.120	Power (VA)/VAR:	26.4 / 25.4
I _{fund} /I _{ref} (Amps):	0.040 / 0.062	Power (W):	7.2
I _{peak} (Amps)/I-CF:	2.256 / 8.050	Power Factor:	0.268
V-THD (%):	0.06	I-THD (%):	273.37
POHC (A):	0.056 (method C.3)	POHC Limit (A):	0.250
I-THC (A):	0.105	Meas. Pwr (Min / Max)	6.9W/24.0W
Phase angle of H5 (deg):	8.7		

Harmonic Spectrum

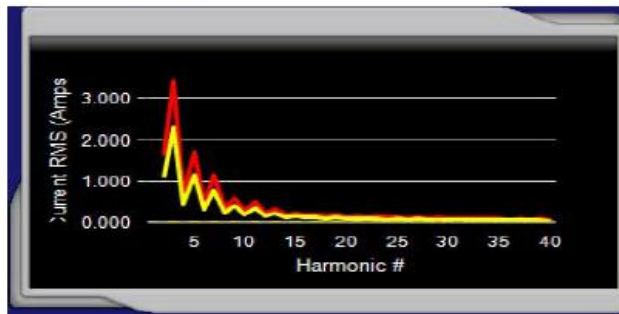

Voltage & Current Waveform

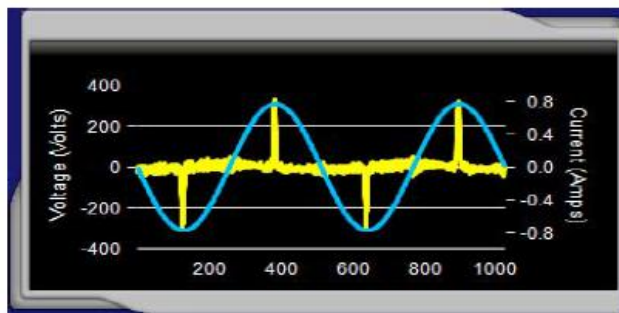

Current Harmonics (values at the end of test)

Harm No.	Harm. Ave.	Harm. Limit (100%)	% Of Limits	Result (Ave.)	Result (Max.)	Harm. Win.	Harm. Win. (150%)	% Of Max
2	0.0009	1.0800	0.1	PASS	PASS	0.0013	1.6200	0.1
3	0.0341	2.3000	1.5	PASS	PASS	0.0567	3.4500	1.6
4	0.0009	0.4300	0.2	PASS	PASS	0.0013	0.6450	0.2
5	0.0334	1.1400	2.9	PASS	PASS	0.0555	1.7100	3.2
6	0.0009	0.3000	0.3	PASS	PASS	0.0013	0.4500	0.3
7	0.0330	0.7700	4.3	PASS	PASS	0.0544	1.1550	4.7
8	0.0010	0.2300	0.4	PASS	PASS	0.0015	0.3450	0.4
9	0.0322	0.4000	8.0	PASS	PASS	0.0527	0.6000	8.8
10	0.0009	0.1840	0.5	PASS	PASS	0.0014	0.2760	0.5
11	0.0313	0.3300	9.5	PASS	PASS	0.0508	0.4950	10.3
12	0.0010	0.1530	0.6	PASS	PASS	0.0016	0.2295	0.7
13	0.0302	0.2100	14.4	PASS	PASS	0.0484	0.3150	15.4
14	0.0009	0.1310	0.7	PASS	PASS	0.0016	0.1965	0.8
15	0.0290	0.1500	19.3	PASS	PASS	0.0458	0.2250	20.4
16	0.0010	0.1150	0.9	PASS	PASS	0.0018	0.1725	1.0
17	0.0276	0.1320	20.9	PASS	PASS	0.0430	0.1980	21.7
18	0.0010	0.1020	0.9	PASS	PASS	0.0017	0.1530	1.1
19	0.0262	0.1180	22.2	PASS	PASS	0.0401	0.1770	22.7
20	0.0010	0.0920	1.1	PASS	PASS	0.0019	0.1380	1.3
21	0.0247	0.1070	23.0	PASS	PASS	0.0369	0.1605	23.0
22	0.0010	0.0830	1.2	PASS	PASS	0.0019	0.1245	1.5
23	0.0230	0.0970	23.7	PASS	PASS	0.0336	0.1455	23.1
24	0.0010	0.0760	1.3	PASS	PASS	0.0019	0.1140	1.7
25	0.0214	0.0900	23.8	PASS	PASS	0.0305	0.1350	22.6
26	0.0009	0.0700	1.3	PASS	PASS	0.0018	0.1050	1.7
27	0.0197	0.0830	23.7	PASS	PASS	0.0272	0.1245	21.9
28	0.0009	0.0650	1.5	PASS	PASS	0.0017	0.0975	1.7
29	0.0180	0.0770	23.3	PASS	PASS	0.0242	0.1155	20.9
30	0.0009	0.0610	1.5	PASS	PASS	0.0018	0.0915	1.9
31	0.0163	0.0720	22.6	PASS	PASS	0.0212	0.1080	19.7
32	0.0010	0.0570	1.7	PASS	PASS	0.0017	0.0855	2.0
33	0.0146	0.0680	21.4	PASS	PASS	0.0183	0.1020	18.0
34	0.0008	0.0540	1.6	PASS	PASS	0.0016	0.0810	2.0
35	0.0129	0.0640	20.2	PASS	PASS	0.0157	0.0960	16.3
36	0.0008	0.0510	1.6	PASS	PASS	0.0014	0.0765	1.8
37	0.0114	0.0600	18.9	PASS	PASS	0.0132	0.0900	14.6
38	0.0008	0.0480	1.6	PASS	PASS	0.0013	0.0720	1.8
39	0.0099	0.0570	17.4	PASS	PASS	0.0110	0.0855	12.9
40	0.0007	0.0460	1.6	PASS	PASS	0.0013	0.0690	1.9

Power Source Verification Data

Harm No.	Harm. Value	Harm. Limit	% Of Limits	% Of Vfund	Result
2	0.031	0.440	7.056	0.014	OK
3	0.103	1.980	5.205	0.047	OK
4	0.015	0.440	3.434	0.007	OK
5	0.060	0.880	6.820	0.027	OK
6	0.036	0.440	8.206	0.016	OK
7	0.036	0.660	5.514	0.017	OK
8	0.043	0.440	9.725	0.020	OK
9	0.025	0.440	5.700	0.011	OK
10	0.034	0.440	7.744	0.016	OK
11	0.035	0.220	16.133	0.016	OK
12	0.015	0.220	6.801	0.007	OK
13	0.034	0.220	15.675	0.016	OK
14	0.030	0.220	13.670	0.014	OK
15	0.032	0.220	14.676	0.015	OK
16	0.016	0.220	7.468	0.007	OK
17	0.033	0.220	14.994	0.015	OK
18	0.014	0.220	6.234	0.006	OK
19	0.034	0.220	15.521	0.016	OK
20	0.021	0.220	9.366	0.009	OK
21	0.038	0.220	17.216	0.017	OK
22	0.025	0.220	11.557	0.012	OK
23	0.029	0.220	13.388	0.013	OK
24	0.018	0.220	8.072	0.008	OK
25	0.029	0.220	13.182	0.013	OK
26	0.019	0.220	8.418	0.008	OK
27	0.029	0.220	13.271	0.013	OK
28	0.014	0.220	6.549	0.007	OK
29	0.027	0.220	12.163	0.012	OK
30	0.014	0.220	6.323	0.006	OK
31	0.026	0.220	11.653	0.012	OK
32	0.015	0.220	6.675	0.007	OK
33	0.026	0.220	12.000	0.012	OK
34	0.016	0.220	7.136	0.007	OK
35	0.023	0.220	10.352	0.010	OK
36	0.018	0.220	8.026	0.008	OK
37	0.029	0.220	13.328	0.013	OK
38	0.020	0.220	9.259	0.009	OK
39	0.023	0.220	10.269	0.010	OK
40	0.018	0.220	8.037	0.008	OK

EUT: Pocket WIFI+LAN(Pocket WIFI+LAN)
Test Standard: Test per IEC 61000-3-2 Ed. 5.1 : 2020
Test Class: (Class A Test) - No inter-harmonics
Test Result: **PASS**
Test Date: 2023/2/14
Start Time: 13:55:10
Stop Time: 13:57:51
Test Duration (min): 2.5
Environment: Temp: 24°C; Humi:42%
Source Qualification: Compliance with IEC 61000-3-2 Ed. 5.1 : 2020
Power Source Distortion: **OK**
Customer: Customer
Test By: Jo Liu
Comments: WIRED

General Test Data: (Phase A)

Vrms (Volts)/V-pk/V-CF:	219.43 / 309.6 / 1.411	Frequency (Hz):	50.0001
I_rms (Amps):	0.120	Power (VA)/VAR:	26.8 / 25.7
I_fund/I_ref (Amps):	0.040 / 0.058	Power (W):	7.2
I_peak (Amps)/I-CF:	2.202 / 7.280	Power Factor:	0.275
V-THD (%):	0.06	I-THD (%):	272.05
POHC (A):	0.057 (method C.3)	POHC Limit (A):	0.250
I-THC (A):	0.107	Meas. Pwr (Min / Max)	6.8W/27.6W
Phase angle of H5 (deg):	8.7		

Harmonic Spectrum

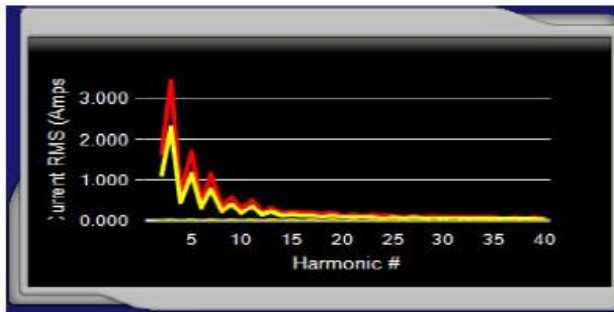

Voltage & Current Waveform

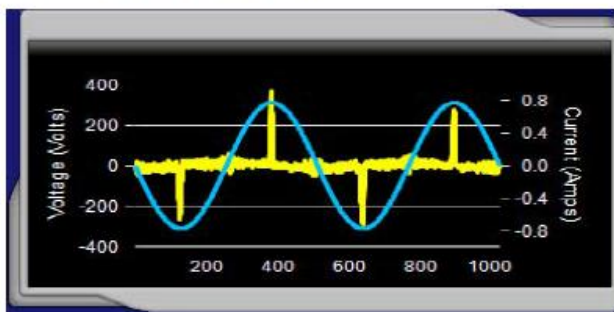

Current Harmonics (values at the end of test)

Harm No.	Harm. Ave.	Harm. Limit (100%)	% Of Limits	Result (Ave.)	Result (Max.)	Harm. Win.	Harm. Win. (150%)	% Of Max
2	0.0009	1.0800	0.1	PASS	PASS	0.0019	1.6200	0.1
3	0.0350	2.3000	1.5	PASS	PASS	0.0520	3.4500	1.5
4	0.0009	0.4300	0.2	PASS	PASS	0.0019	0.6450	0.3
5	0.0343	1.1400	3.0	PASS	PASS	0.0508	1.7100	3.0
6	0.0009	0.3000	0.3	PASS	PASS	0.0018	0.4500	0.4
7	0.0338	0.7700	4.4	PASS	PASS	0.0498	1.1550	4.3
8	0.0010	0.2300	0.4	PASS	PASS	0.0019	0.3450	0.5
9	0.0329	0.4000	8.2	PASS	PASS	0.0480	0.6000	8.0
10	0.0010	0.1840	0.5	PASS	PASS	0.0019	0.2760	0.7
11	0.0320	0.3300	9.7	PASS	PASS	0.0461	0.4950	9.3
12	0.0010	0.1530	0.7	PASS	PASS	0.0019	0.2295	0.8
13	0.0308	0.2100	14.7	PASS	PASS	0.0437	0.3150	13.9
14	0.0010	0.1310	0.7	PASS	PASS	0.0019	0.1965	1.0
15	0.0296	0.1500	19.7	PASS	PASS	0.0413	0.2250	18.4
16	0.0010	0.1150	0.9	PASS	PASS	0.0019	0.1725	1.1
17	0.0282	0.1320	21.4	PASS	PASS	0.0386	0.1980	19.5
18	0.0010	0.1020	1.0	PASS	PASS	0.0019	0.1530	1.2
19	0.0267	0.1180	22.6	PASS	PASS	0.0358	0.1770	20.2
20	0.0011	0.0920	1.1	PASS	PASS	0.0019	0.1380	1.4
21	0.0251	0.1070	23.5	PASS	PASS	0.0328	0.1605	20.5
22	0.0010	0.0830	1.2	PASS	PASS	0.0019	0.1245	1.5
23	0.0234	0.0970	24.2	PASS	PASS	0.0300	0.1455	20.6
24	0.0010	0.0760	1.4	PASS	PASS	0.0018	0.1140	1.6
25	0.0217	0.0900	24.1	PASS	PASS	0.0274	0.1350	20.3
26	0.0010	0.0700	1.4	PASS	PASS	0.0018	0.1050	1.7
27	0.0200	0.0830	24.1	PASS	PASS	0.0248	0.1245	20.0
28	0.0010	0.0650	1.5	PASS	PASS	0.0017	0.0975	1.7
29	0.0182	0.0770	23.6	PASS	PASS	0.0223	0.1155	19.3
30	0.0009	0.0610	1.5	PASS	PASS	0.0017	0.0915	1.8
31	0.0165	0.0720	22.9	PASS	PASS	0.0197	0.1080	18.2
32	0.0010	0.0570	1.7	PASS	PASS	0.0017	0.0855	2.0
33	0.0147	0.0680	21.6	PASS	PASS	0.0172	0.1020	16.8
34	0.0009	0.0540	1.7	PASS	PASS	0.0015	0.0810	1.9
35	0.0131	0.0640	20.4	PASS	PASS	0.0150	0.0960	15.6
36	0.0009	0.0510	1.7	PASS	PASS	0.0015	0.0765	1.9
37	0.0114	0.0600	19.1	PASS	PASS	0.0130	0.0900	14.4
38	0.0008	0.0480	1.7	PASS	PASS	0.0014	0.0720	1.9
39	0.0100	0.0570	17.5	PASS	PASS	0.0110	0.0855	12.8
40	0.0008	0.0460	1.7	PASS	PASS	0.0012	0.0690	1.7

Power Source Verification Data

Harm No.	Harm. Value	Harm. Limit	% Of Limits	% Of Vfund	Result
2	0.030	0.440	6.788	0.014	OK
3	0.102	1.980	5.159	0.047	OK
4	0.015	0.440	3.357	0.007	OK
5	0.059	0.880	6.734	0.027	OK
6	0.033	0.440	7.403	0.015	OK
7	0.038	0.660	5.758	0.017	OK
8	0.043	0.440	9.681	0.019	OK
9	0.026	0.440	5.994	0.012	OK
10	0.034	0.440	7.678	0.015	OK
11	0.040	0.220	18.059	0.018	OK
12	0.013	0.220	5.871	0.006	OK
13	0.034	0.220	15.550	0.016	OK
14	0.030	0.220	13.741	0.014	OK
15	0.037	0.220	16.831	0.017	OK
16	0.017	0.220	7.793	0.008	OK
17	0.034	0.220	15.259	0.015	OK
18	0.014	0.220	6.389	0.006	OK
19	0.042	0.220	19.120	0.019	OK
20	0.020	0.220	8.937	0.009	OK
21	0.038	0.220	17.369	0.017	OK
22	0.023	0.220	10.243	0.010	OK
23	0.031	0.220	14.017	0.014	OK
24	0.017	0.220	7.835	0.008	OK
25	0.038	0.220	17.095	0.017	OK
26	0.014	0.220	6.242	0.006	OK
27	0.030	0.220	13.793	0.014	OK
28	0.016	0.220	7.465	0.007	OK
29	0.026	0.220	11.824	0.012	OK
30	0.018	0.220	8.086	0.008	OK
31	0.025	0.220	11.291	0.011	OK
32	0.013	0.220	6.132	0.006	OK
33	0.024	0.220	10.850	0.011	OK
34	0.015	0.220	6.876	0.007	OK
35	0.023	0.220	10.410	0.010	OK
36	0.019	0.220	8.712	0.009	OK
37	0.024	0.220	10.732	0.011	OK
38	0.020	0.220	9.058	0.009	OK
39	0.021	0.220	9.634	0.010	OK
40	0.017	0.220	7.802	0.008	OK

9. VOLTAGE FLUCTUATION AND FLICKER MEASUREMENT

9.1. Block Diagram of Test Setup

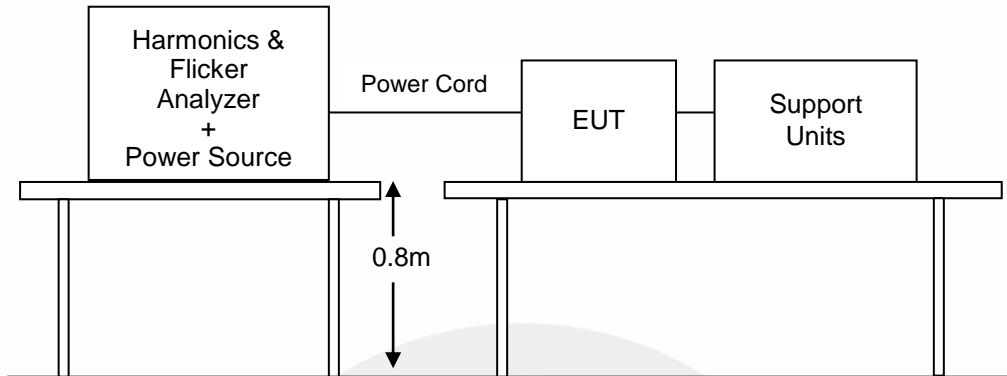

9.2. Standard Limits

EN 61000-3-3 Limits

The objective of voltage changes, voltage fluctuations and flicker in public low voltage supply systems during equipment with rated current ≤ 16 A per phase, ensures that home appliances and certain other electrical equipment do not adversely affect lighting equipment when connected to the same power system.

Voltage Fluctuation and Flicker Limits:

- the value of P_{st} shall not be greater than 1.0;
- the value of Plt shall not be greater than 0.65;
- the value of $d(t)$ during a voltage change shall not exceed 3.3 % for more than 500 ms;
- the relative steady-state voltage change, dc , shall not exceed 3.3 %;
- the maximum relative voltage change, d_{max} , shall not exceed 4.0 %;

9.3. Test Procedure

The total impedance of the test circuit, excluding the appliance under test, but including the internal impedance of the supply source, shall be equal to the reference impedance. The stability and tolerance of the reference impedance shall be adequate to ensure that the overall accuracy of 8% is achieved during the whole assessment procedure.

9.4. Test Results

Pass.

Please refer to the following pages.

EUT:	Pocket WIFI+LAN(Pocket WIFI+LAN)
Test Standard:	Test per IEC 61000-3-3 Ed. 3.1 : 2017
Test Class:	Flicker Test, Pst-dc-dmax-Tmax
Test Result:	PASS
Test Date:	2023/2/14
Start Time:	13:43:16
Stop Time:	13:53:30
Test Duration (min):	10
Environment:	Temp: 24°C; Humi:42%
<u>Source Qualification:</u>	Compliance with IEC 61000-3-3 Ed. 3.1 : 2017
Customer:	Customer
Test By:	Jo Liu
Comments:	WIFI

Phase A

Vrms (Volts):	219.42	Frequency (Hz):	50.00
I_rms (Amps):	0.113	Power (W):	8.7
V-THD (%):	0.157	T-Max (ms):	0 (500)
dmax (%):	0.000 (4.000)	Hi dmax (%):	0.000 (4.000)
dc (%):	0.000 (3.300)	Hi dc (%):	0.000 (3.300)
Pst-1 :	0.039 (1.000)		
Plt :	0.017 (0.650)		

Pst Spectrum

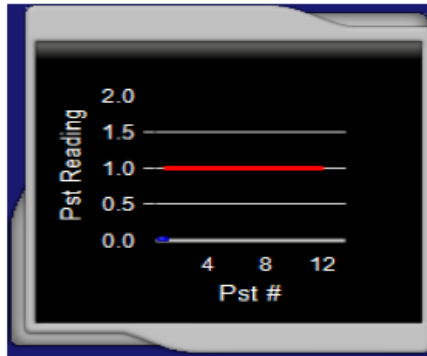

Plt Spectrum



EUT:	Pocket WIFI+LAN(Pocket WIFI+LAN)
Test Standard:	Test per IEC 61000-3-3 Ed. 3.1 : 2017
Test Class:	Flicker Test, Pst-dc-dmax-Tmax
Test Result:	PASS
Test Date:	2023/2/14
Start Time:	14:00:20
Stop Time:	14:10:42
Test Duration (min):	10
Environment:	Temp: 24°C; Humi:42%
Source Qualification:	Compliance with IEC 61000-3-3 Ed. 3.1 : 2017
Customer:	Customer
Test By:	Jo Liu
Comments:	WIRED

Phase A

Vrms (Volts):	219.45	Frequency (Hz):	50.00
I_{rms} (Amps):	0.098	Power (W):	7.4
V-THD (%):	0.142	T-Max (ms):	0 (500)
dmax (%):	0.000 (4.000)	Hi dmax (%):	0.000 (4.000)
dc (%):	0.000 (3.300)	Hi dc (%):	0.000 (3.300)
Pst-1 :	0.039 (1.000)		
Plt :	0.017 (0.650)		

Pst Spectrum

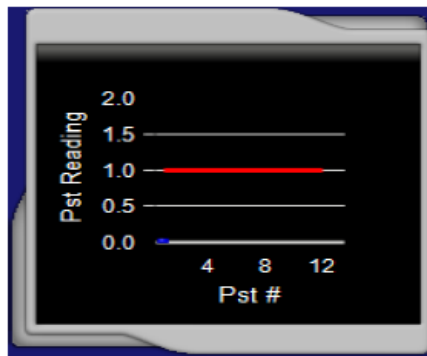

Plt Spectrum



10. IMMUNITY GENERAL PERFORMANCE CRITERIA DESCRIPTION

General performance criteria are defined in EN 55035 clause 8.2, 8.3 and 8.4. These criteria shall be used during the testing of primary functions where no relevant annex is applicable.

When assessing the impact of a disturbance on a function, the assessment should take into consideration the function's performance prior to the application of the disturbance and only identify as failures those changes in performance that are a result of the disturbance.

EN 55035:

Performance criterion A

The equipment shall continue to operate as intended without operator intervention. No degradation of performance, loss of function or change of operating state is allowed below a performance level specified by the manufacturer when the equipment is used as intended. The performance level may be replaced by a permissible loss of performance. If the minimum performance level or the permissible performance loss is not specified by the manufacturer, then either of these may be derived from the product description and documentation, and by what the user may reasonably expect from the equipment if used as intended.

Performance criterion B

During the application of the disturbance, degradation of performance is allowed. However, no unintended change of actual operating state or stored data is allowed to persist after the test.

After the test, the equipment shall continue to operate as intended without operator intervention; no degradation of performance or loss of function is allowed, below a performance level specified by the manufacturer, when the equipment is used as intended. The performance level may be replaced by a permissible loss of performance.

If the minimum performance level (or the permissible performance loss), or recovery time, is not specified by the manufacturer, then either of these may be derived from the product description and documentation, and by what the user may reasonably expect from the equipment if used as intended.

Performance criterion C

Loss of function is allowed, provided the function is self-recoverable, or can be restored by the operation of the controls by the user in accordance with the manufacturer's instructions. A reboot or re-start operation is allowed. Information stored in non-volatile memory, or protected by a battery backup, shall not be lost.

11. ELECTROSTATIC DISCHARGE

11.1. Test Specification

Test standard	: EN 55035
Basic standard	: IEC 61000-4-2
Performance criterion	: B
Test level	: ±8.0kV (Air discharge) ±4.0kV (Contact discharge)

11.2. Block Diagram of Test Setup

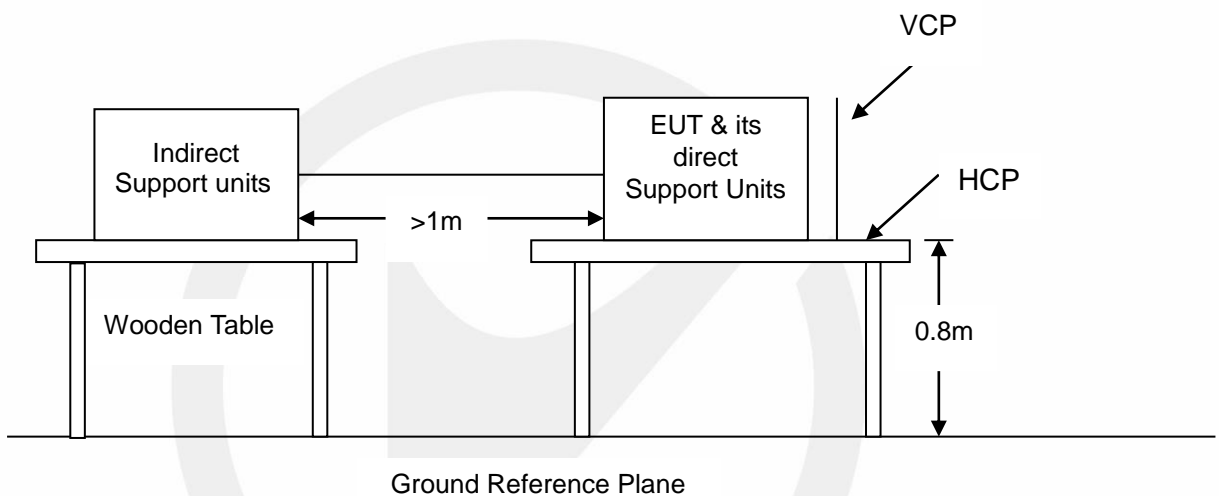

11.3. Test Procedure

- In the case of air discharge testing, the climatic conditions shall be within the following ranges:
 - ambient temperature: 15°C to 35°C;
 - relative humidity : 30% to 60%;
 - atmospheric pressure : 86 kPa (860 mbar) to 106 kPa (1060 mbar)
- Test programs and software shall be chosen so as to exercise all normal modes of operation of the EUT. The use of special exercising software is encouraged, but permitted only where it can be shown that the EUT is being comprehensively exercised.
- In the case of contact discharges, the tip of the discharge electrode shall touch the EUT before the discharge switch is operated.
- In the case of painted surface covering a conducting substrate, the following procedure shall be adopted :
 - If the coating is not declared to be an insulating coating by the equipment manufacturer, then the pointed tip of the generator shall penetrate the coating so as to make contact with the conducting substrate.
 - Coating declared as insulating by the manufacturer shall only be submitted to the air discharge.
 - The contact discharge test shall not be applied to such surfaces.
- In the case of air discharges, the round discharge tip of the discharge electrode shall be approached as fast as possible (without causing mechanical damage) to touch the EUT. After each discharge, the ESD generator (discharge electrode) shall be removed from the EUT. The generator is then retriggered for a new single discharge. This procedure shall be repeated until the discharges are completed. In the case of an air discharge test, the discharge switch, which is used for contact discharge, shall be closed.

- f. The test voltage shall be increased from the minimum to the selected test severity level, in order to determine any threshold of failure. The final test level should not exceed the product specification value in order to avoid damage to the equipment.
- g. The test shall be performed with both air discharge and contact discharge. The test shall be performed with single discharges. On each pre-selected point at least 10 single discharges (in the most sensitive polarity) shall be applied. For the time interval between successive single discharges an initial value of 1 s is recommended. Longer intervals may be necessary to determine whether a system failure has occurred.
- h. Ensure that the applied charge on the EUT has been dis-charged before next ESD pulse.

11.4. Test Results

Pass.

Temperature : 21 °C
 Humidity : 49 %
 Atmospheric Pressure : 101kpa
 Test Engineer : Jo Liu
 Test Date : 2023-02-14

Air Discharge:

Test Voltage	Location	Actual criterion	Required performance criterion	Result (Pass/Fail)
±2; 4; 8 kV	All slots of the EUT	A	B	Pass
±2; 4; 8 kV	Non-Conducted Enclosure	A	B	Pass

Contact Discharge

Test Voltage	Location	Actual criterion	Required performance criterion	Result (Pass/Fail)
±2; 4kV	/	/	B	/
±2; 4kV	/	/	B	/

Indirect Discharge

Test Voltage	Location	Actual criterion	Required performance criterion	Result (Pass/Fail)
±2; 4 kV	HCP	A	B	Pass
±2; 4kV	VCP	A	B	Pass

12. CONTINUOUS RF ELECTROMAGNETIC FIELD DISTURBANCES

12.1. Test Specification

Test standard	: EN 55035	
Basic standard	: IEC 61000-4-3	
Performance criterion	: A	
Frequency range &	: <input checked="" type="checkbox"/> 80M-1000MHz	3V/m
Test level	: <input checked="" type="checkbox"/> Spot frequency	3V/m
	: <input type="checkbox"/> Additional spot frequency	3V/m
Modulation	: AM, 80%, 1kHz sine-wave	

12.2. Block Diagram of Test Setup

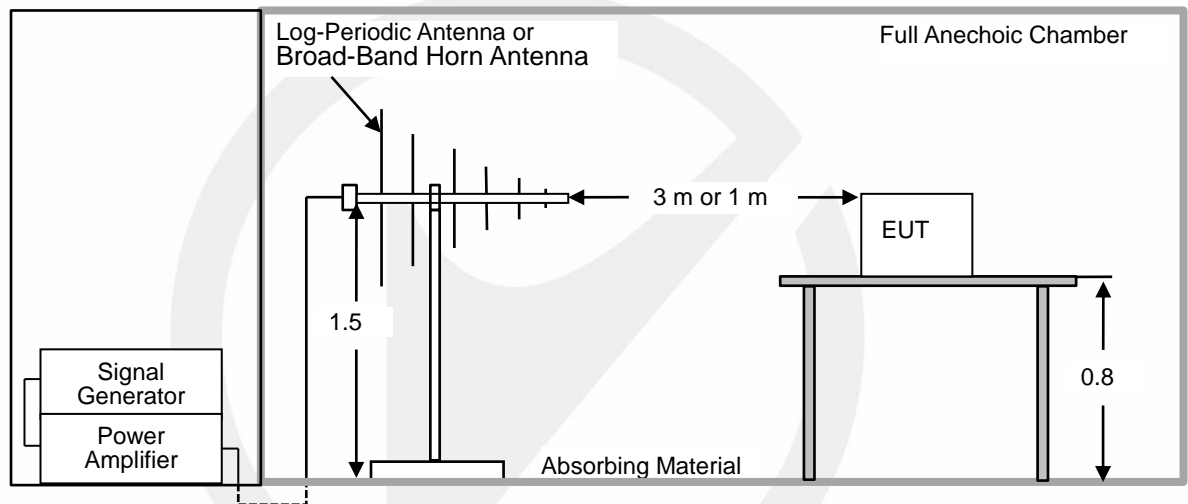

12.3. Test procedure

The procedure defined in this part requires the generation of electromagnetic fields within which the test sample is placed and its operation observed. To generate fields that are useful for simulation of actual (field) conditions may require significant antenna drive power and the resultant high field strength levels. To comply with local regulations and to prevent biological hazards to the testing personnel, it is recommended that these tests be carried out in a shielded enclosure or semi-anechoic chamber.

- a. The antenna which is enabling the complete frequency range of 80-1000 MHz is placed 3m (or 1m) away from the equipment. The required field strength is determined by placing the field strength meter(s) on top of or directly alongside the equipment under test and monitoring the field strength meter via a remote field strength indicator outside the enclosure while adjusting the continuous-wave to the antenna.
- b. The test is performed with the antenna facing the front and back sides of the EUT with. Both vertical and horizontal polarizations from antenna are tested.

12.4. Test results

Pass.

Temperature : 24°C
 Humidity : 47 %
 Atmospheric Pressure : 101kpa
 Test Engineer : Jo Liu
 Test Date : 2023-02-14

80M-1000MHz:

Freq. Range (MHz)	Field	Modulation	Polarity	Position (°)	Actual criterion	Required performance criterion	Result
80-1000	3V/m	AM, 80%	H / V	0, 90,180, 270	A	A	Pass

Spot frequency:

Freq (MHz)	Field	Modulation	Polarity	Position (°)	Actual criterion	Required performance criterion	Result
1800, 2600, 3500, 5000	3V/m	AM, 80%	H / V	0, 90,180, 270	A	A	Pass

Additional spot frequency:

Freq (MHz)	Field	Modulation	Polarity	Position (°)	Actual criterion	Required performance criterion	Result
80, 120, 160, 230, 434, 460, 600, 863, 900	3V/m	AM, 80%	H / V	0, 90,180, 270	N/A	A	N/A

13. ELECTRICAL FAST TRANSIENTS/BURST

13.1. Test Specification

Test standard : EN 55035
 Basic standard : IEC 61000-4-4
 Performance criterion : B
 Test level : 1kV, AC mains power ports
 0.5kV, DC network power ports
 0.5kV, Analogue/digital data ports
 Repetition frequency : 5kHz, 100kHz(Only xDSL ports)
 Tr/Th: : 5/50ns
 Burst period : 300ms
 Test time : : 120s

13.2. Block Diagram of Test Setup

AC Lines:

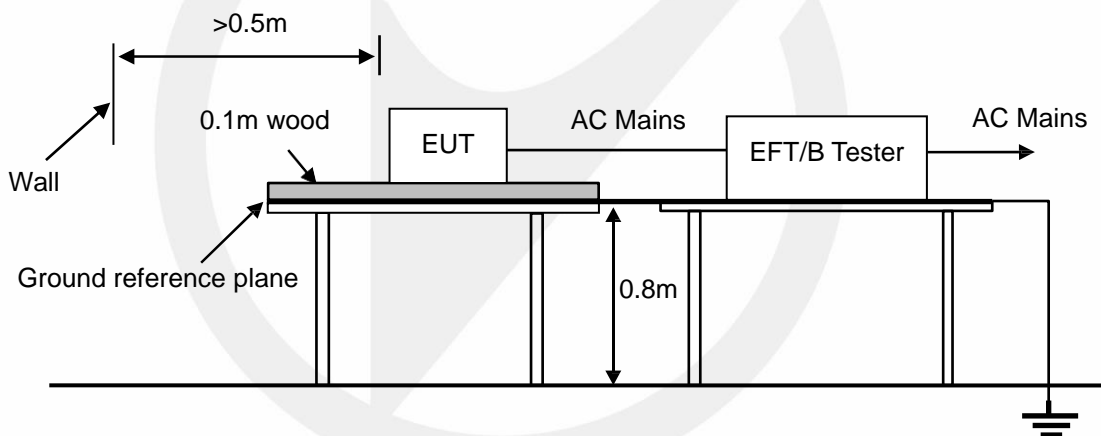

Signal lines:

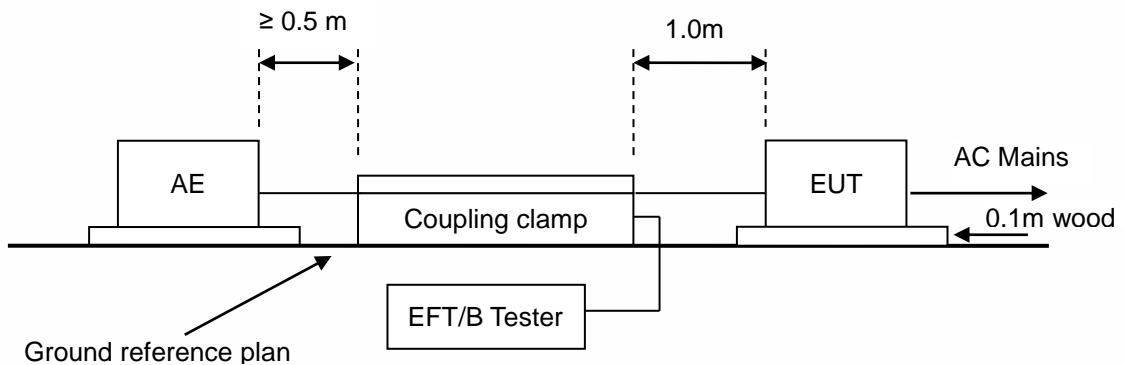

13.3. Test Procedure

The EUT is put on the table that is 0.8 meter high above the ground. This reference ground plane shall project beyond the EUT by at least 0.1m on all sides and the minimum distance between EUT and all other conductive structure, except the ground plane beneath the EUT, shall be more than 0.5m.

13.4. Test Results

Pass.

Temperature : 24 °C
 Humidity : 42%
 Atmospheric Pressure : 101kpa
 Test Engineer : Jo Liu
 Test Date : 2023-02-14

Injection Line	Voltage (kV)	Injected Method	Actual criterion	Required performance criterion	Result (Pass/Fail)
<input checked="" type="checkbox"/> AC mains power ports	± 1	<input type="checkbox"/> CDN <input checked="" type="checkbox"/> Direct injection <input type="checkbox"/> Capacitive coupling clamp	A	B	Pass
<input type="checkbox"/> DC network power ports	± 0.5	<input type="checkbox"/> CDN <input type="checkbox"/> Direct injection <input type="checkbox"/> Capacitive coupling clamp	N/A	B	N/A
<input checked="" type="checkbox"/> Analogue/digital data ports (Wired network port)	± 0.5	<input type="checkbox"/> CDN <input type="checkbox"/> Direct injection <input checked="" type="checkbox"/> Capacitive coupling clamp	A	B	Pass
<input type="checkbox"/> Analogue/digital data ports (Broadcast receiver tuner port)	± 0.5	<input type="checkbox"/> CDN <input type="checkbox"/> Direct injection <input type="checkbox"/> Capacitive coupling clamp	N/A	B	N/A
<input type="checkbox"/> Analogue/digital data ports (.....)	± 0.5	<input type="checkbox"/> CDN <input type="checkbox"/> Direct injection <input type="checkbox"/> Capacitive coupling clamp	N/A	B	N/A

14. SURGES

14.1. Test Specification

Test standard	: EN 55035
Basic standard	: IEC 61000-4-5
Test level	: <input checked="" type="checkbox"/> 1kV, Line to Line, AC mains power ports, Criterion B
	: <input checked="" type="checkbox"/> 2kV, Line to Earth, AC mains power ports, Criterion B
	: <input type="checkbox"/> 0.5kV, Line to Reference ground, DC network power ports, Criterion B
	: <input type="checkbox"/> 1.0kV, 4.0kV, Lines to Ground, Unshielded symmetrical, where primary protection is intended, Criterion C
	: <input checked="" type="checkbox"/> 1.0kV, Lines to Ground, Unshielded symmetrical, where primary protection is not intended Criterion C
	: <input type="checkbox"/> 0.5kV, Shield to ground, Coaxial or shielded port, Criterion B
Number of surges	: 5 (for each combination of parameters)
Repetition rate	: 1 minute / time
Polarity:	: Positive / Negative
Phase angle:	: 90°, 270° (Only AC mains power ports)

14.2. Block Diagram of Test Setup

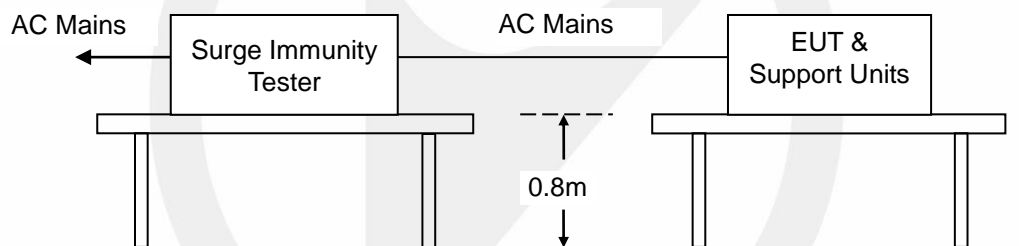

14.3. Test Procedure

This test simulates a lightning event by inducing transients onto the AC/DC power supply lines in common mode (Line to Ground) and differential mode (Line to Line). Each device was tested in a total of two surge configurations: Line to Ground (L-G): Combination Wave, Line to Protective Earth with 9uF and 10Ohm and Neutral to Protective Earth with 9uF and 10Ohm, common mode, generator earthed.

Line to Line (L-L): Combination Wave,

Line to Neutral with 18uF, differential mode, generator floated.

2 ohm : the source impedance of the low-voltage power supply network.

12 ohm : the source impedance of the low-voltage power supply network and ground.

- If not otherwise specified the surges have to be applied synchronized to the voltage phase at the zero-crossing and the peak value of the a.c. voltage wave (positive and negative).
- The surges have to be applied line to line and line to earth. When testing line to earth, the test voltage has to be applied successively between each of the lines and earth, if there is no other specification.
- The test procedure shall also consider the non-linear current-voltage characteristics of the equipment under test. Therefore the test voltage has to be increased by steps up to the test level specified in the product standard or test plan. All lower levels including the selected test level shall be satisfied.
- For testing the secondary protection, the output voltage of the generator shall be increased up to the worst-case voltage breakdown level (let-through level) of the primary protection.
- Testing shall be performed according to a Test Plan, which shall be included in the test report.
- To find all critical points of the duty cycle of the equipment, a sufficient number of positive and negative test pulses shall be applied.

14.4. Test results

Pass.

Temperature : 24 °C
 Humidity : 42%
 Atmospheric Pressure : 101kpa
 Test Engineer : Jo Liu
 Test Date : 2023-02-14

AC mains power ports:

Coupling Line	Voltage (kV)	Waveform (μs)	Polarity	Actual criterion	Required performance criterion	Result (Pass/Fail)
<input checked="" type="checkbox"/> Line to line	1	1.2/50 (8/20)	Pos./ Neg.	A	B	Pass
<input checked="" type="checkbox"/> Line to earth	2	1.2/50 (8/20)	Pos./ Neg.	A	B	Pass

DC network power ports:

Coupling Line	Voltage (kV)	Waveform (μs)	Polarity	Actual criterion	Required performance criterion	Result (Pass/Fail)
Line to Reference ground	0.5	1.2/50 (8/20)	Pos./ Neg.	N/A	B	N/A

Analogue/digital data ports:

Port type	Coupling Line	Voltage (kV)	Waveform (μs)	Polarity	Actual criterion	Required performance criterion	Result (Pass/Fail)
<input checked="" type="checkbox"/> Unshielded symmetrical (Wired network port)	Lines to ground	0.5, 1	10/700 (5/320)	Pos./ Neg.	A	C	Pass
<input type="checkbox"/> Unshielded symmetrical (.....)	Lines to ground	0.5, 1	10/700 (5/320)	Pos./ Neg.	N/A	C	N/A
<input type="checkbox"/> Unshielded symmetrical	Lines to ground	0.5, 1, 2, 4	10/700 (5/320)	Pos./ Neg.	N/A	C	N/A
<input type="checkbox"/> Coaxial or shielded (Broadcast receiver tuner port)	Shield to ground	0.5	1.2/50 (8/20)	Pos./ Neg.	N/A	B	N/A
<input type="checkbox"/> Coaxial or shielded (.....)	Shield to ground	0.5	1.2/50 (8/20)	Pos./ Neg.	N/A	B	N/A

15. CONTINUOUS INDUCED RF DISTURBANCES

15.1. Test Specification

Test standard	: EN 55035
Basic standard	: IEC 61000-4-6
Performance criterion	: A
Frequency range &	: 0.15M to 10MHz, 3V
Test level	: 10M to 30MHz, 3V to 1V 30M to 80MHz, 1V
Modulation	: AM 80%, 1kHz sine-wave
Frequency Step	: 1% of fundamental

15.2. Block Diagram of Test Setup

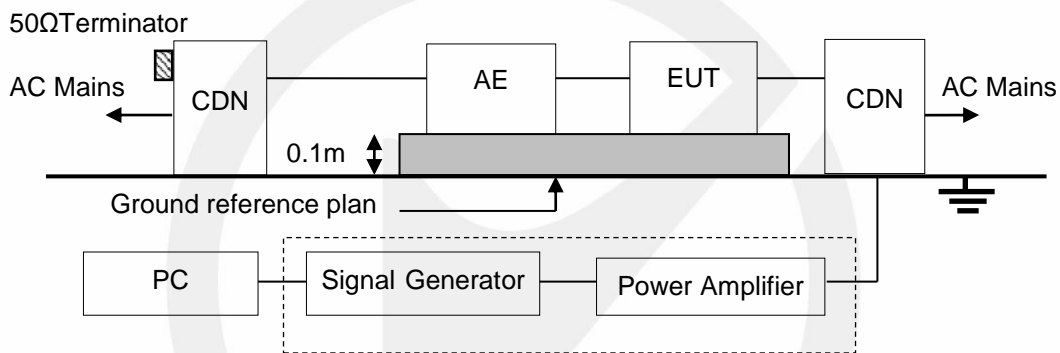

15.3. Test Procedure

- The EUT shall be operated within its intended climatic conditions. The temperature and relative humidity should be recorded.
- The EUT is placed on a 0.1m high test table, and a well grounded cable is connected to metallic plane above the test table.
- All cables/wires must be laid out on test plate (3cm in thickness), and the EUT is set up on test plate (10 cm in thickness) as shown in test setup photo, and the cables/wires must not be in mid-air, they should be touching the surface of test plate. Ensure that the EUT is properly connected to the accessory equipment.
- The test shall be performed with the test generator connected to each of the coupling and decoupling devices in turn while the other non-excited RF-input ports of the coupling devices are terminated by a 50 ohm load resistor.
- The frequency range is swept from 150 kHz to 80 MHz, using the signal levels established during the setting process, and with the disturbance signal 80% amplitude modulated with a 1 kHz sine wave, pausing to adjust the RF-signal level or to switch coupling devices as necessary. The rate of sweep shall no exceed 1.5×10^{-3} decades/s. Where the frequency is swept incrementally, the step size shall no exceed 1% of the start and thereafter 1% of the preceding frequency value.
- The dwell time at each frequency shall not be less than the time necessary for the EUT to be exercised, and able to respond. Sensitive frequencies e.g. clock frequency (ies) and harmonics or frequencies of dominant interest shall be analyzed separately.
- Attempts should be made to fully exercise the EUT during testing, and to fully interrogate all exercise modes selected for susceptibility
- Testing shall be performed according to a Test Plan, which shall be included in the test report.

15.4. Test results

Pass.

Temperature : 24 °C
 Humidity : 42%
 Atmospheric Pressure : 101kpa
 Test Engineer : Jo Liu
 Test Date : 2023-02-14

Range (MHz)	Levers (V)	Injection port	Coupling type	Actual criterion	Required performance criterion	Result (Pass/Fail)
0.15-10	3	<input checked="" type="checkbox"/> AC mains power ports	<input checked="" type="checkbox"/> CDN	A	A	Pass
10-30	3-1		<input type="checkbox"/> EM Clamp			
30-80	1		<input type="checkbox"/> Current Clamp <input type="checkbox"/> Direct injection			
0.15-10	3	<input type="checkbox"/> DC network power ports	<input type="checkbox"/> CDN	N/A	A	N/A
10-30	3-1		<input type="checkbox"/> EM Clamp			
30-80	1		<input type="checkbox"/> Current Clamp <input type="checkbox"/> Direct injection			
0.15-10	3	<input checked="" type="checkbox"/> Analogue/digital data ports (Wired network port)	<input type="checkbox"/> CDN	A	A	Pass
10-30	3-1		<input type="checkbox"/> EM Clamp			
30-80	1		<input checked="" type="checkbox"/> Current Clamp <input type="checkbox"/> Direct injection			
0.15-10	3	<input type="checkbox"/> Analogue/digital data ports (Broadcast receiver tuner port)	<input type="checkbox"/> CDN	N/A	A	N/A
10-30	3-1		<input type="checkbox"/> EM Clamp			
30-80	1		<input type="checkbox"/> Current Clamp <input type="checkbox"/> Direct injection			
0.15-10	3	<input type="checkbox"/> Analogue/digital data ports (.....)	<input type="checkbox"/> CDN	N/A	A	N/A
10-30	3-1		<input type="checkbox"/> EM Clamp			
30-80	1		<input type="checkbox"/> Current Clamp <input type="checkbox"/> Direct injection			

16. VOLTAGE DIPS AND INTERRUPTIONS

16.1. Test Specification

Test standard	: EN 55035
Basic standard	: IEC 61000-4-11
Test level	: 0%, 0.5 period, Criterion B
	<input checked="" type="checkbox"/> 70%, 25 periods for 50Hz, Criterion C
	<input type="checkbox"/> 70%, 30 periods for 60Hz, Criterion C
	<input checked="" type="checkbox"/> 0%, 250 periods for 50Hz, Criterion C
	<input type="checkbox"/> 0%, 300 periods for 60Hz, Criterion C

16.2. Block Diagram of Test Setup

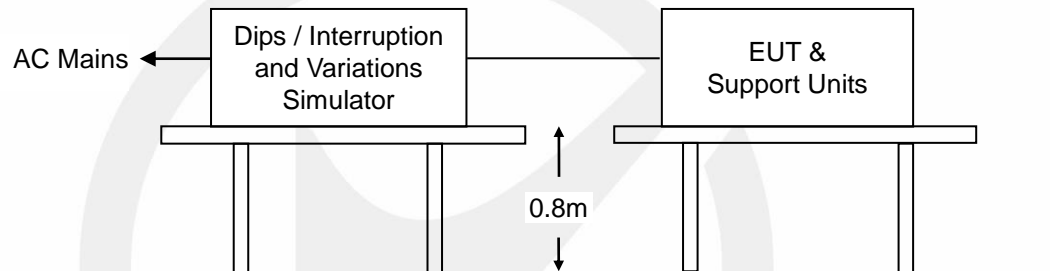

16.3. Test Procedure

- Where the equipment has a rated voltage the following shall apply - If the voltage range does not exceed 20% of the lower voltage specified for the rated voltage range, a single voltage within that range may be specified as a basis for test level specification.
 - In all other cases, the test procedure shall be applied for both the lowest and highest voltages declared in the voltage range.
- Test Conditions
 - Select operated voltage and frequency of EUT - Test of interval : 10 sec.
 - Level and duration : Sequence of 3 dips/interrupts.
 - Voltage rise (and fall) time : 1.5 μ s.

16.4. Test results

Pass.

Temperature : 24 °C
 Humidity : 42%
 Atmospheric Pressure : 101kpa
 Test Engineer : Jo Liu
 Test Date : 2023-02-14

Item	Test Level (% UT)	Phase angle (°)	Input Voltage (V)	Freq (Hz)	Duration (periods)	Actual criterion	Required performance criterion	Result (Pass /Fail)
<input checked="" type="checkbox"/> Voltage dips	0%	0°, 180°	AC 230V	50	0.5	A	B	Pass
<input type="checkbox"/> Voltage dips	0%	0°, 180°	AC 230V	60	0.5	N/A	B	N/A
<input checked="" type="checkbox"/> Voltage dips	70%	0°, 180°	AC 230V	50	25	A	C	Pass
<input type="checkbox"/> Voltage dips	70%	0°, 180°	AC 230V	60	30	N/A	C	N/A
<input checked="" type="checkbox"/> Voltage interruptions	0%	0°, 180°	AC 230V	50	250	B	C	Pass
<input type="checkbox"/> Voltage interruptions	0%	0°, 180°	AC 230V	60	300	N/A	C	N/A

17. PHOTOGRAPHS

17.1. Photo of Conducted Emission Measurement



17.2. Photo of Conducted Emissions at Telecommunications/network port Measurement

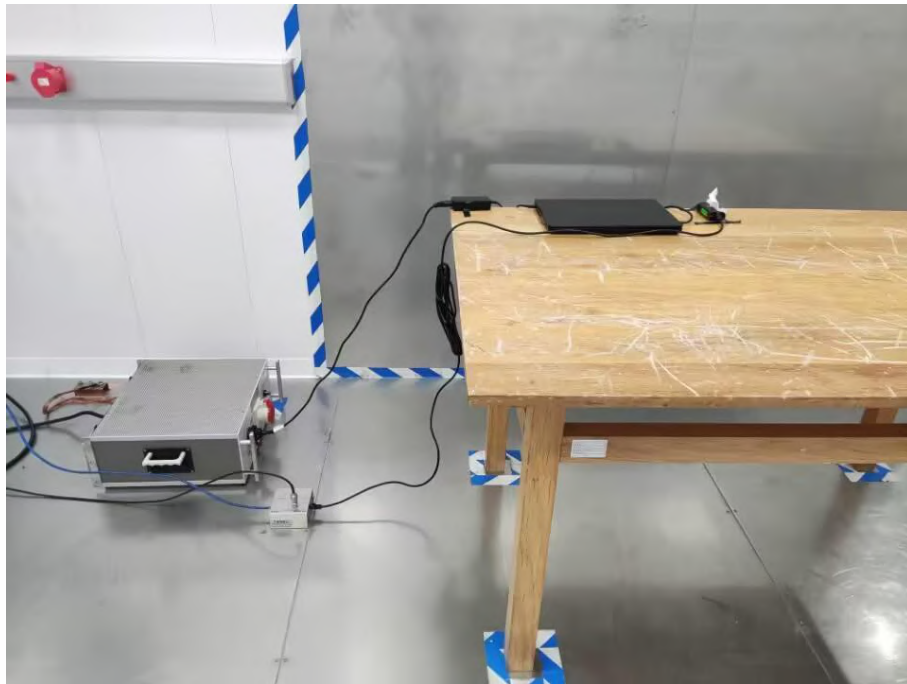

17.3.Photo of Radiation Emission Measurement (Up to 1GHz)



17.4.Photo of Radiation Emission Measurement (Above 1GHz)

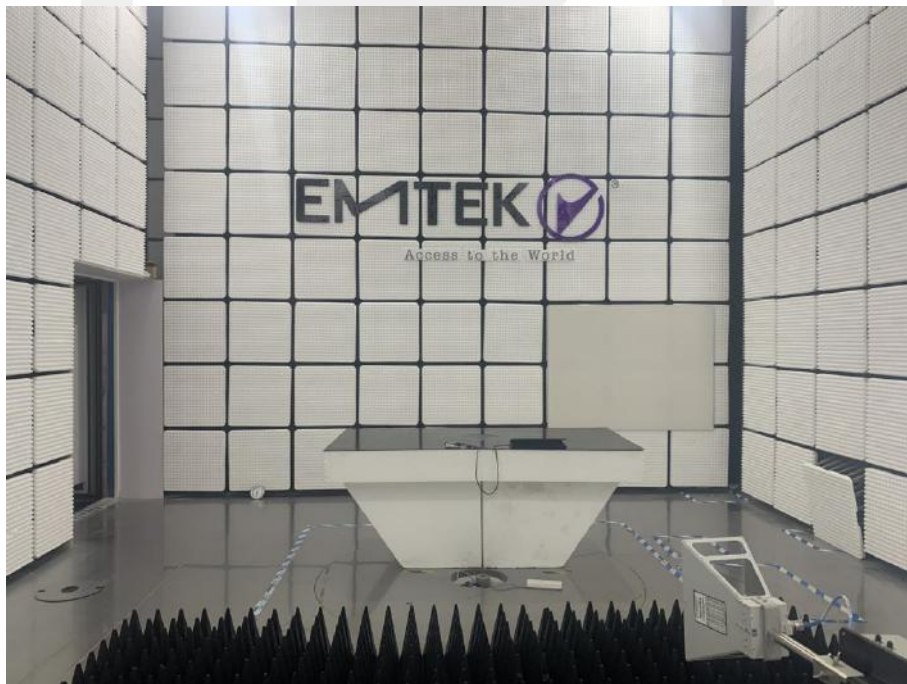
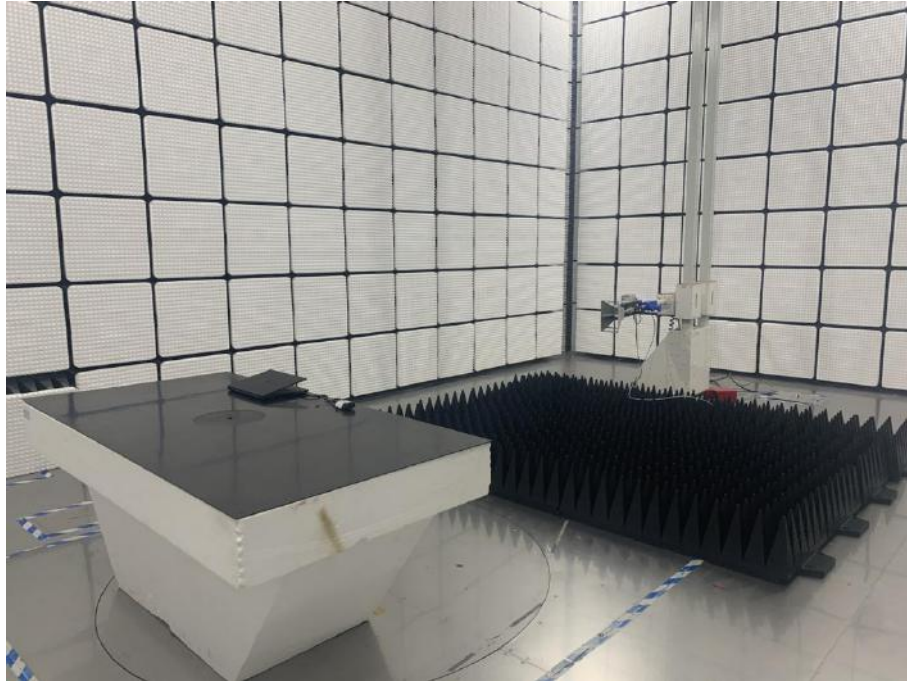

17.5.Photo of Harmonic and Flicker Measurement



17.6.Photo of Electrostatic Discharge Test

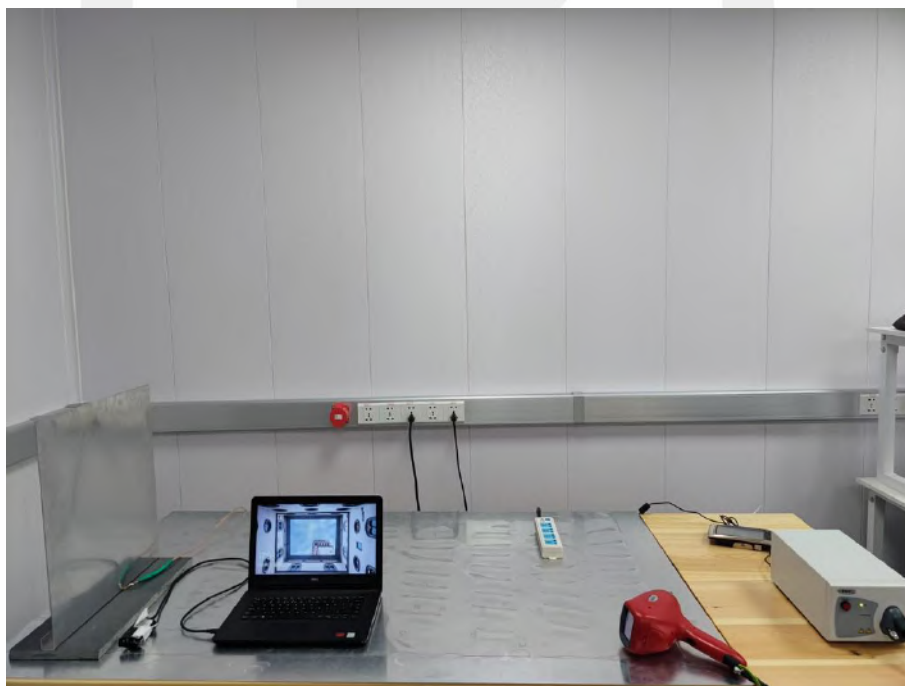

17.7.Photo of RF Field Strength Susceptibility Test

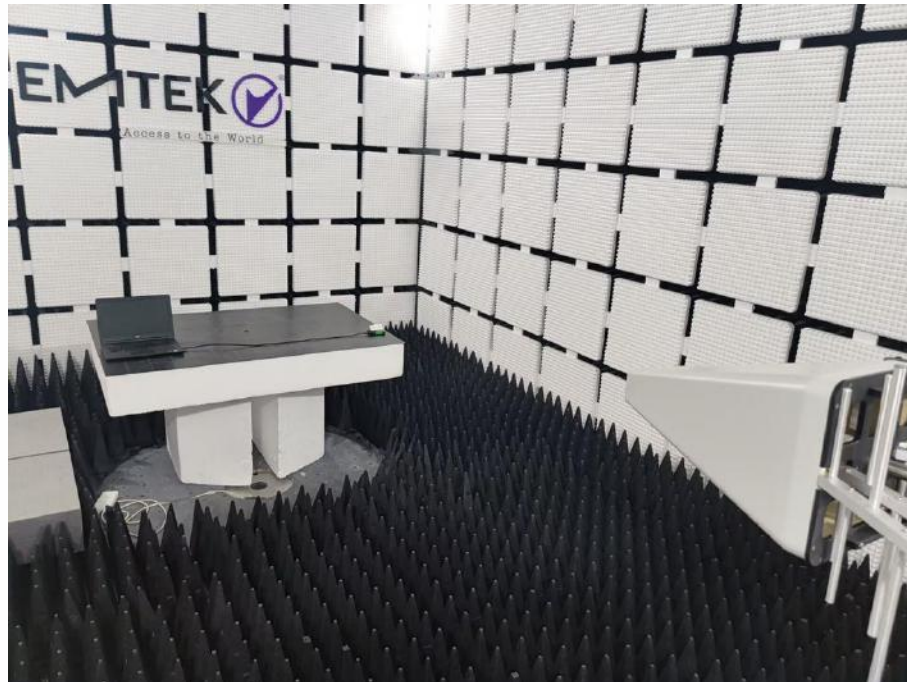

17.8.Photo of Electrical Fast Transient /Burst Test



17.9.Photo of Surge Test



17.10.Photo of Injected Currents Susceptibility Test



17.11.Photo of Voltage Dips and Interruption Immunity Test

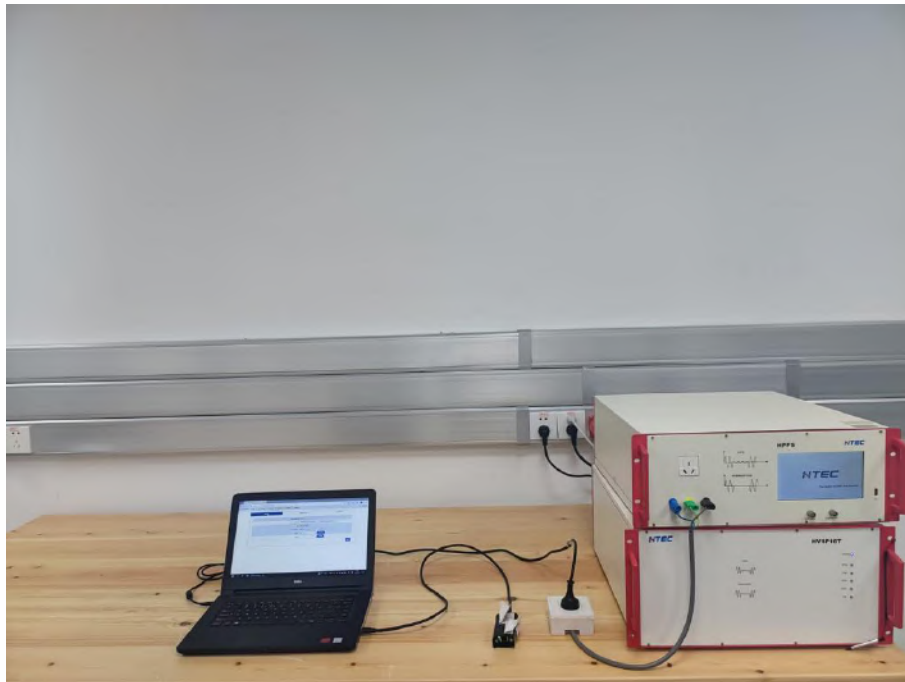



**APPENDIX
(PHOTOS OF EUT)**



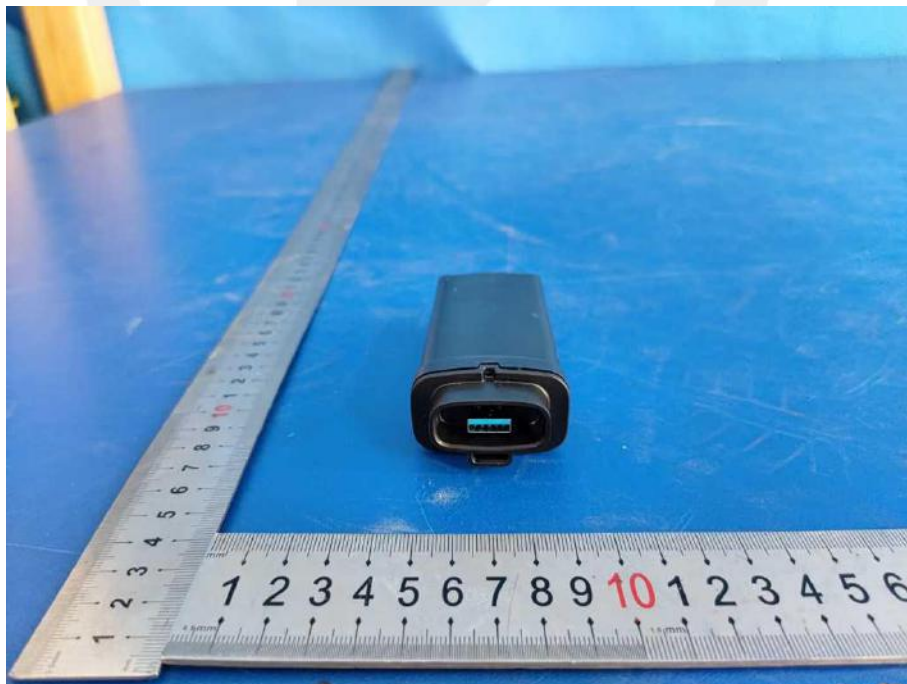

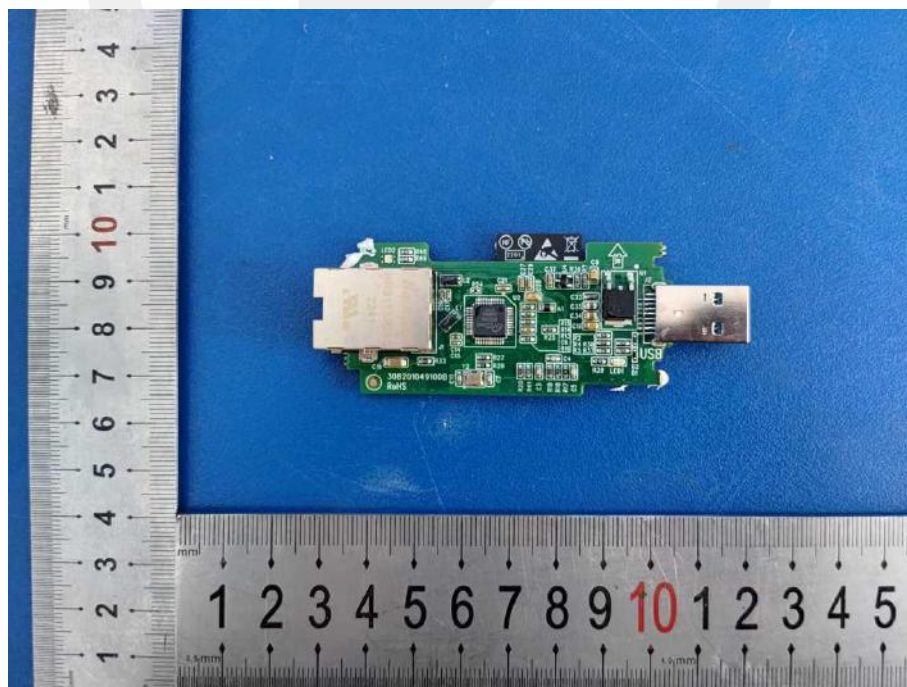
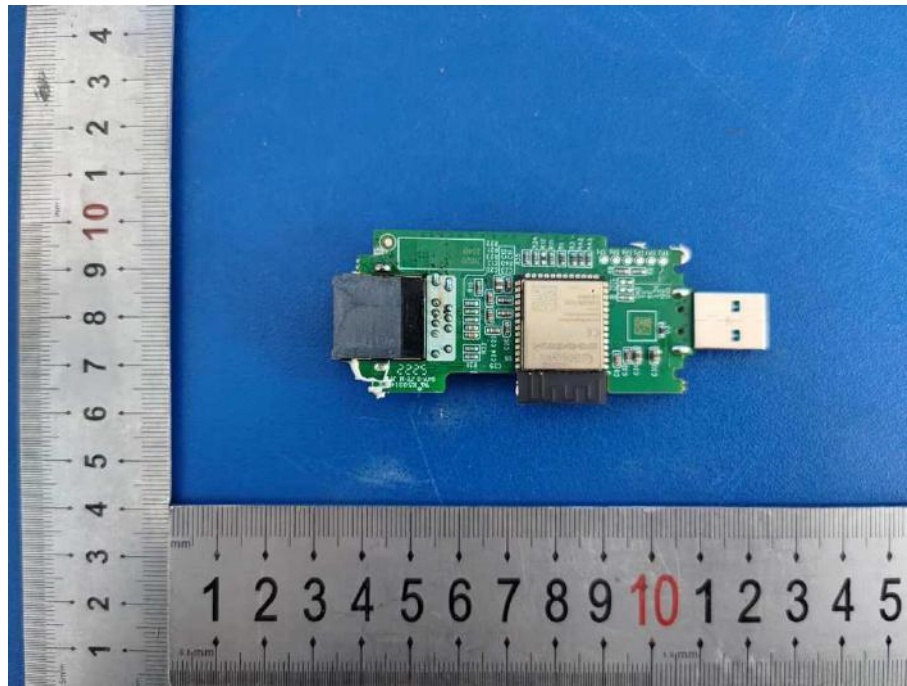

*** End of Report ***

声明 Statement

1. 本报告无授权批准人签字及“检验检测专用章”无效；

This report will be void without authorized signature or special seal for testing report.

2. 未经许可本报告不得部分复制；

This report shall not be copied partly without authorization.

3. 本报告的检测结果仅对送测样品有效，委托方对样品的代表性和资料的真实性负责；

The test results or observations are applicable only to tested sample. Client shall be responsible for representativeness of the sample and authenticity of the material.

4. 本检测报告中检测项目标注有特殊符号则该项目不在资质认定范围内，仅作为客户委托、科研、教学或内部质量控制等目的使用；

The observations or tests with special mark fall outside the scope of accreditation, and are only used for purpose of commission, research, training, internal quality control etc.

5. 本检测报告以实测值进行符合性判定，未考虑不确定度所带来的风险，本实验室不承担相关责任，特别约定、标准或规范中有明确规定的除外；

The test results or observations are provided in accordance with measured value, without taking risks caused by uncertainty into account. Without explicit stipulation in special agreements, standards or regulations, EMTEK shall not assume any responsibility.

6. 对本检测报告若有异议，请于收到报告之日起 20 日内提出；

Objections shall be raised within 20 days from the date receiving the report.